



TOTAL SOLUTIONS FOR AUTOMATIC WELDING & CUTTING



www.lincolnelectriceurope.com





ISO
OERLIKON

ISO OERLIKON AG Schweisstechnik

CH-5737 Menziken AG – Tel. +41 (0)62 771 83 05

E-Mail info@iso-oerlikon.ch – www.iso-oerlikon.ch



"Automation" is an excellent opportunity for companies looking for continuous Improvement and performances. For Lincoln Electric the automation of welding and cutting processes is not new, but rather a source of innovation that we want to share with our customers.

We invest heavily in the development of intelligent welding and cutting technology solutions to combine the quality and performance you want.

Automation in general brings important changes in the way you organize your workshops. It is for this reason that the pooling of our expertise in the search for the most suitable solution is essential in order to increase your productivity, the reliability, the safety of your staff, all in the greatest respect of the environment.

This catalog is a concentrate of technology, and you will find I am sure a response to your manufacturing needs, but the easiest for you is still to contact us, so that together we realize your "factory of the future".

I wish you a good visit.

Jörg Müller

Managing Director Europe Automation



SUMMARY

TOTAL AUTOMATIC WELDING AND CUTTING SOLUTIONS



INDUSTRY SEGMENTS	5		
CUTTING SYSTEMS	14		
CUTTING PROCESSES PRESENTATION	15		
PLASMA POWER SOURCES RANGE	17		
- TOMAHAWK® 1538	18		
- FLEXCUT® 125	19		
- FINELINE®	20		
- NERTAJET HPI	22		
OXYCUTTING RANGE	23		
CUTTING MACHINE RANGE	24		
- LINC-CUT® S	25		
- OPTITOME ²	26		
- PLASMATOME ² HD	27		
- EUROTOME ²	28		
- OXYTOME ² & PLASMATOME ²	29		
- OXYTOME & PLASMATOME TWIN	30		
		HPC DIGITAL PROCESS 3	32
		CUTTING SOFTWARE	34
		EXTRACTION TABLES	36
		FUME EXTRACTION	38
		OPTIONS	39
		- NERTAJET bevel HPI	39
		- Tube cutting & 4 th axis	40
		- Numerical drilling unit	41
		- Complement for machine	42
		- Equipment for oxyfuel process	43
		PYTHON X STRUCTURAL	44



WELDING SYSTEMS	46		
WELDING PROCESSES PRESENTATION	47		
TIG & PLASMA WELDING	48		
- LINC-MASTER	49		
- Control panels	51		
- TOPTIG	52		
- PLASMA & TIG machines	53		
SUBMERGED ARC WELDING	55		
- Power source	56		
- SAW installation	57		
- Control panels	58		
- SAW heads & applications	59		
- SAW equipment	60		
- SAW tractors	61		
		- SAW multiple wires	62
		- Strip cladding processes	63
		- SAW column & boom	65
		- SAW internal boom	66
		- BEAM-MATIC installation	67
		- Lamp post solutions	68
		- Gantry solutions	69
		MIG / MAG WELDING	70
		- MIG/MAG welding carriages ..	72
		- Orbital welding	74
		- LINC-COBOT	76
		- FLEX-FAX robotic welding cells	78
		- Automated Guided Vehicles ..	81
		- Structural welding & assembly	82
		- Precision Power Laser	86
		POSITIONING	88
		- LINC-MATIC column & booms	88
		- SEAM-MATIC seamer benches	89
		- ROTAMATIC ST single roller beds	90
		- ROTAMATIC LP single roller beds	91
		- ROTAMATIC TR fit up roller beds	92
		- ROTAMATIC LP-2R self aligning roller beds	93
		- POSIMATIC positioners	94
		- HEADMATIC headstock	95
		- TURNMATIC turntable	96
SERVICES	97		

TOTAL AUTOMATIC WELDING AND CUTTING SOLUTIONS



Lincoln Electric offers a large choice of cutting and welding solutions for many segments and diverse industries.

**AUTOMATION IS
THE SOLUTION TO:**

IMPROVE **QUALITY**
INCREASE **THROUGHPUT**
IMPROVE **WORKER SAFETY**

REDUCE **COSTS**
ADDRESS **SHORTAGE
OF LABOUR**





Chemical or food processing, pressure vessels, tanks, general industries

Plasma & Oxyfuel cutting system
with bevelling unit

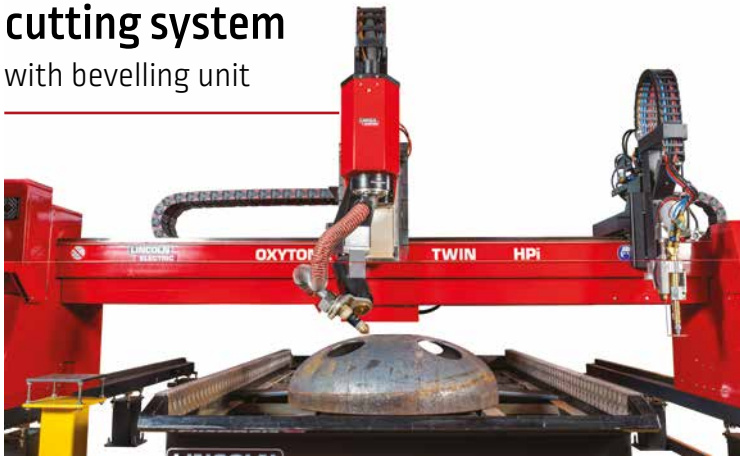

Clamping bench



Handling



Column & boom





Transportation, automotive, heavy fabrication

Cutting system
Plasma High
Precision



Column
& boom



Beam welder

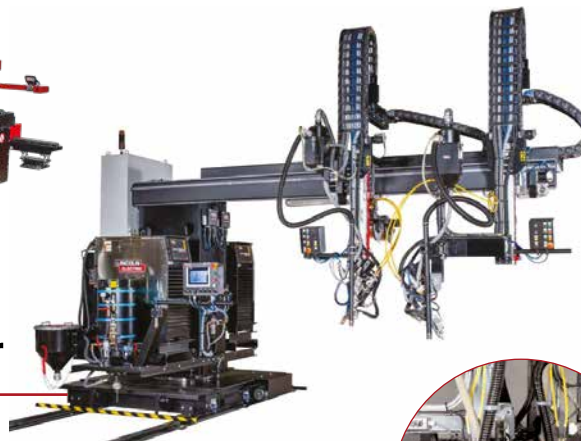

Gantry

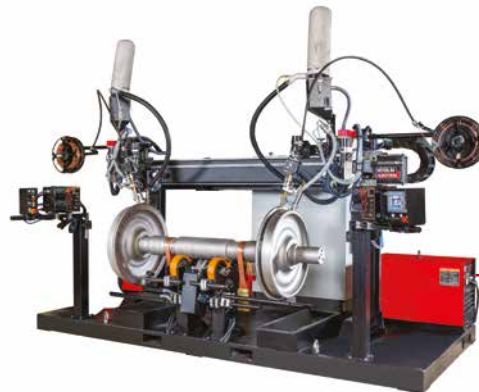
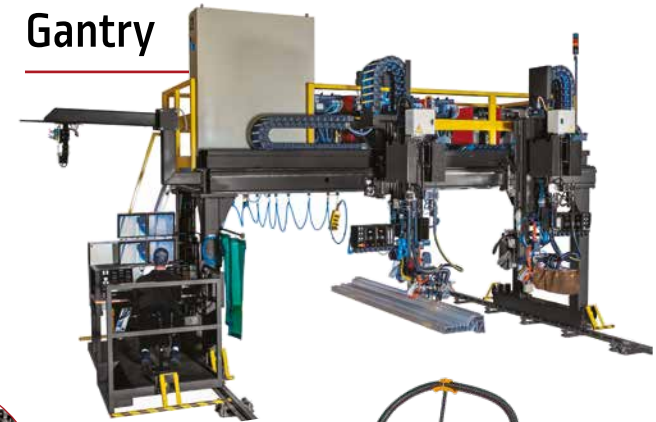

Lathe

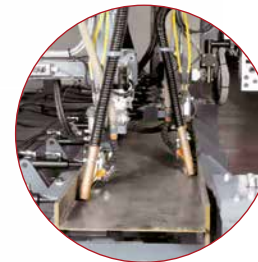

Cobot





Pipe production, pipeline

SAW gantry



Multi-arcs

Plasma + TIG



Up to 5 SAW



Internal boom

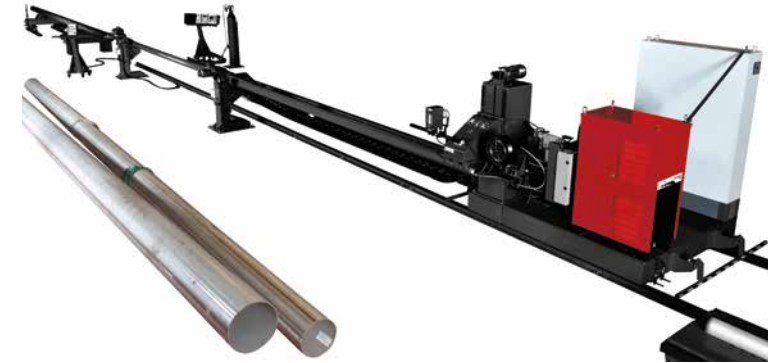



Process piping, offshore, pipe mill

Side beam



Column & boom



Plasma cutting system with tube cutting



Orbital welding





Structural

Cutting system High Precision



Steel Beam Assembly



Python X Structural

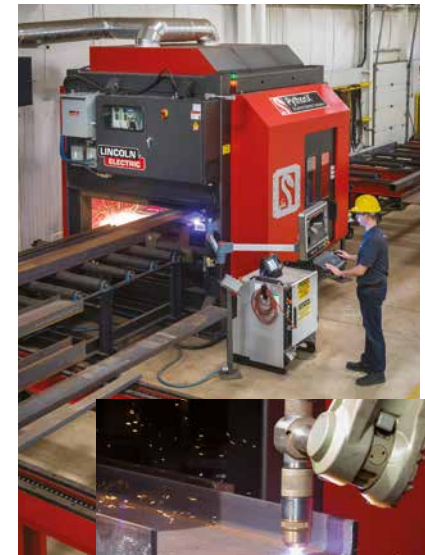

Beam welder & Clamping bench





Power generation, energy

Plasma & oxyfuel cutting system



SAW tandem MEGATRAC tractor

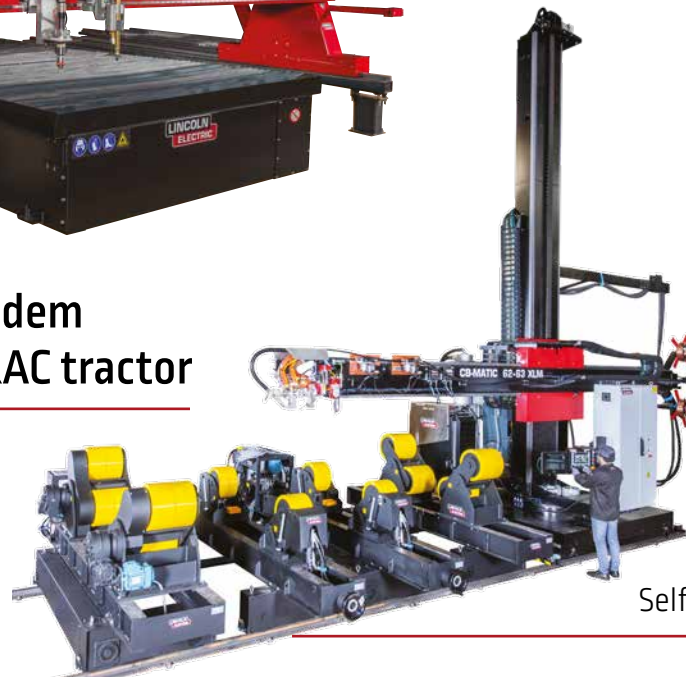
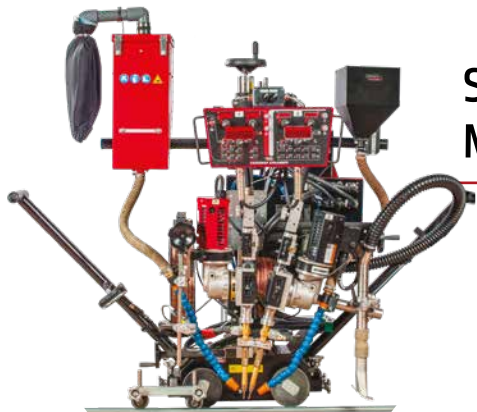

Orbital welding



Column & boom



Growing line
Self aligning roller beds



Shipbuilding

Plasma & Oxyfuel cutting system



Beam welder



Portable tractors MIG/MAG





Distribution, sub-contractors, locksmiths

Compact cutting machines



Handling



Robotic cells



CUTTING SYSTEMS



TOTAL SOLUTION PROVIDER



Advance cutting process and improved data base parameters



A machine equipped with a numerical control with high performance



Table & fume extraction



Efficient software and post processor



Technician with cutting expertise

ISO 9013: Main cutting quality criteria

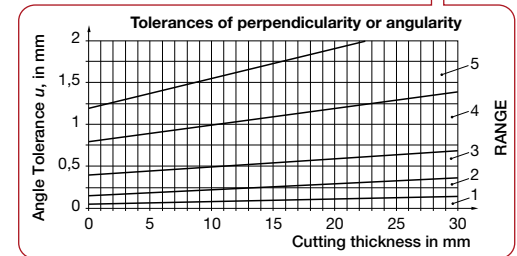
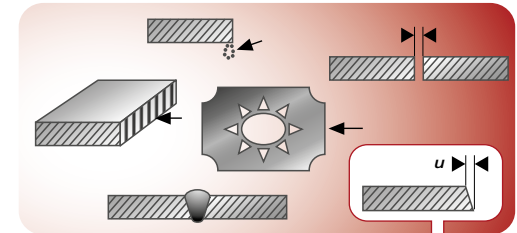

Various features can be evaluated to understand the cutting quality. EN standard ISO 9013 retains mainly three:

- Geometric accuracy
- Roughness surface
- Angle / concentricity

This last criteria determines, based on the thickness, the perpendicularity tolerance in five classifications (ranges 1 to 5).

FINELINE® HD complies with EN 1090 infrastructure manufacturing standard.



It sets the requirements for the execution of steel structures to ensure appropriate levels of mechanical resistance, stability, service ability and durability.

Thermal cutting and particularly FINELINE® HD is identified as a process that can be used in the realization of steel structure: cuts & bolt holes.

NERTAJET HPI Heavy power



600 A

FineLine® HD High definition



300 A

FLEXCUT® 125 Industrial air plasma



125 A

TOMAHAWK® 1538 Industrial air plasma



100 A

Plasma thickness range multi material

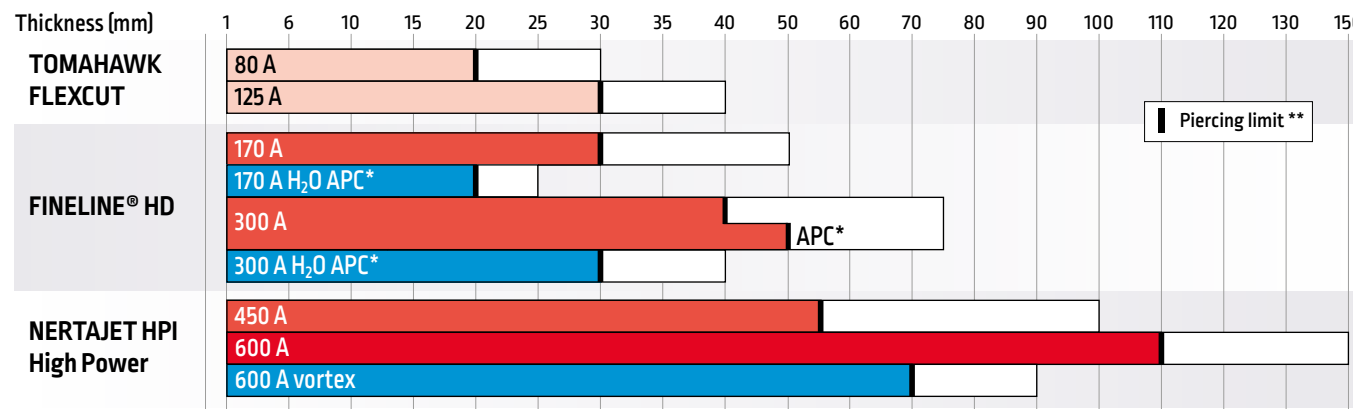

* APC, advanced process control
** Maximum piercing can be different depending the material

TOMAHAWK® 1538

100A Air Plasma Cutter

Versatile, qualitative, economical in automatic or manual cutting

The TOMAHAWK® 1538 is a plasma cutting power source with contact ignition and compressed air, allowing **automatic or manual cutting up to 30 mm and automatic piercing up to 20 mm.**

It is particularly easy to set up and use and is built with the LINCOLN ELECTRIC robust power sources design and is **guaranteed for 3 years.**

The consumables are specially designed to produce superior and economical cutting qualities with very thin and medium thicknesses using compressed air whilst also at ease cutting and piercing thicknesses up to 20 mm to produce small parts.

The TOMAHAWK® 1538 can work with:

- The LC105 manual torch
- The LC100M automatic torch

Both can be exchanged quickly using the central connector.

Range of thickness for TOMAHAWK® 1538 plasma cutting system

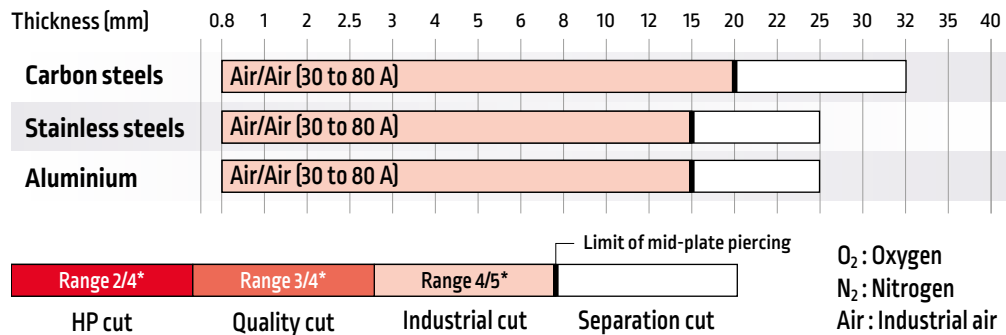

* following ISO9013, standards for classification of thermal cuts



TOMAHAWK® 1538 - SPECIFICATIONS

Input Power Voltage/Phase/Hertz	400 V (+/-15%) - 3 ph - 50/60 Hz
Input power	7.1 kW @ 100% (12 A) 13.7 kW @ 40% (23 A)
Output Range	LC100M auto torch: 20-80 A LC105 manual torch: 20-100 A
Air Pressure Required	6.5 to 7 bars
Air Flow Rate	180 l/min
Dimensions / weight	455 x 301 x 618 / 36 kg



FLEXCUT® 125

125A Air Plasma Cutter

Make the cut in the big game

Low Operating Costs

Keeping costs under control is important to any efficient plasma cutting operation. The FlexCut® 125 ensures up to six times longer consumable life and maintains faster cut speeds - both of which deliver higher productivity over less time. The completed cut is virtually dross-free, which means less secondary processing.

Best Cutting and Marking Performance

The FlexCut® 125 is designed to deliver on all fronts as the only machine in it's class that allows you to plasma mark. Whether you are piercing up to 25 mm* mild steel material in a mechanized cutting application, or cutting expanded metal, you can count on less edge bevel and superior edge quality compared to competing cutting systems.

** Increase your plate piercing capability up to 30 mm on carbon steel by using this system on machines equipped with our advance cycle manage by HPC3*

Range of thickness for FLEXCUT® 125 plasma cutting system

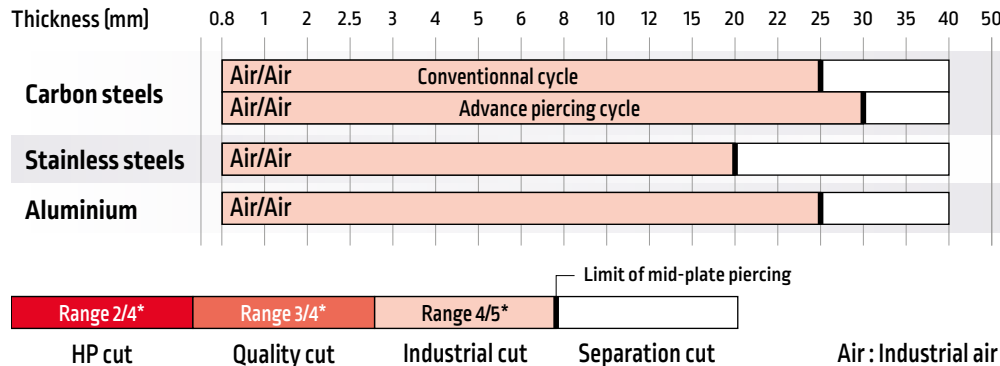

* following ISO9013, standards for classification of thermal cuts



Easy to Set, Easy to Use, polyvalence of the applications

Whether you want to cut on sheet metal, make a bevel, plasma marker or cut on grating, the FlexCut® 125 plasma cutter requires very little time or effort to get down to the business of cutting. Controls are simple, which makes setup easy, and you can get a consistent and reliable arc without needing to rely on high-frequency start systems.

The simple user interface provides a means to configure output pressure based on torch length.

Polyvalence is also possibility to use Flexcut® 125 with manual torch PT130 quickly exchangeable to cut up to 50 mm.



Cutting



Marking



Grid



Bevel

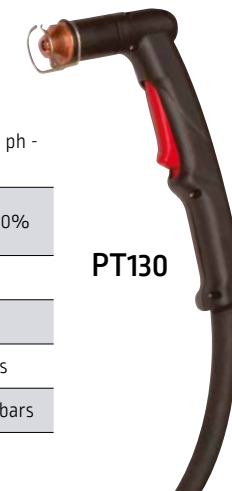

FLEXCUT® 125 - SPECIFICATIONS

Input Power Voltage/Phase/ Hertz	380/400/415 V - 3 ph - 50/60 Hz
Rated Output: Current / Voltage / Duty Cycle	125 A / 175 V / 100%
Input Current	40 A
Output Range	20-125 A
Air Pressure Required	6.2 to 8.3 bars
Air Flow Rate	260 l/min at 6.2 bars
Net Weight	53.5 kg

FineLine® HD 170 & 300

High Definition Plasma Cutting Systems



Quality high precision cutting beyond the market standard

Quality:

- Dimensional and geometrical accuracy of pieces cut, on a wide range of materials
- Surface face cut quality (*roughness far below than that of a laser*)
- A cut angle (*range 2 to 4 in accordance with ISO 9013*)
- Remarkably straight holes on carbon steel with **ULTRA SHARP 2.0**
- Cuts with no adhering slag
- Quality maintained due to the optimised life time and wear compensation function **CDHC**
- Compatible with EN1090 requirements



Operating costs:

The **FineLine® HD** systems work to obtain an economical cutting price:

- Extended life time of wear parts
- Low O₂ gas consumption unlike other plasma HD systems or laser
- Eco Design conception with inverter technology reducing electrical power consumption
- High cutting speed associated with advanced **CYCLE BOOST** and **INSTANT MARKING** functions



2X PLUS
Consumable Life*
Against Competitor A



Up to
54% LESS
Plasma Gas Usage*

FineLine® 300HD
140A

Competitor A
130A

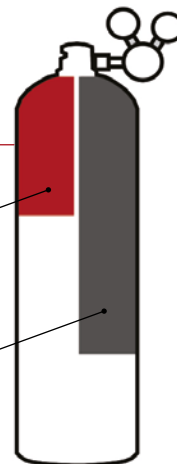

FineLine®
Gas Controller



FineLine®
Art Start Console



*Cutting at 140A on PythonX STRUCTUAL using the FineLine® 300HD System

Advanced Process Control (APC):



The FineLine® Advanced Process Controller provides the most advanced technologies with water injection. Water injection increases speed when cutting stainless and aluminum, significantly reducing gas cost and improving cut edge quality, with less dross formation.



FineLine® Advanced Process Controller

Surface spatter is very difficult to control during the plasma cutting process. The FineLine® Advanced Process Controller, using the Advanced Piercing Technology, enables 1:1 holes to be cut in heavier gauge material, achieving the same quality as large holes and helping to reduce pierce time, whilst increasing consumable life.



Range of thickness for FineLine®

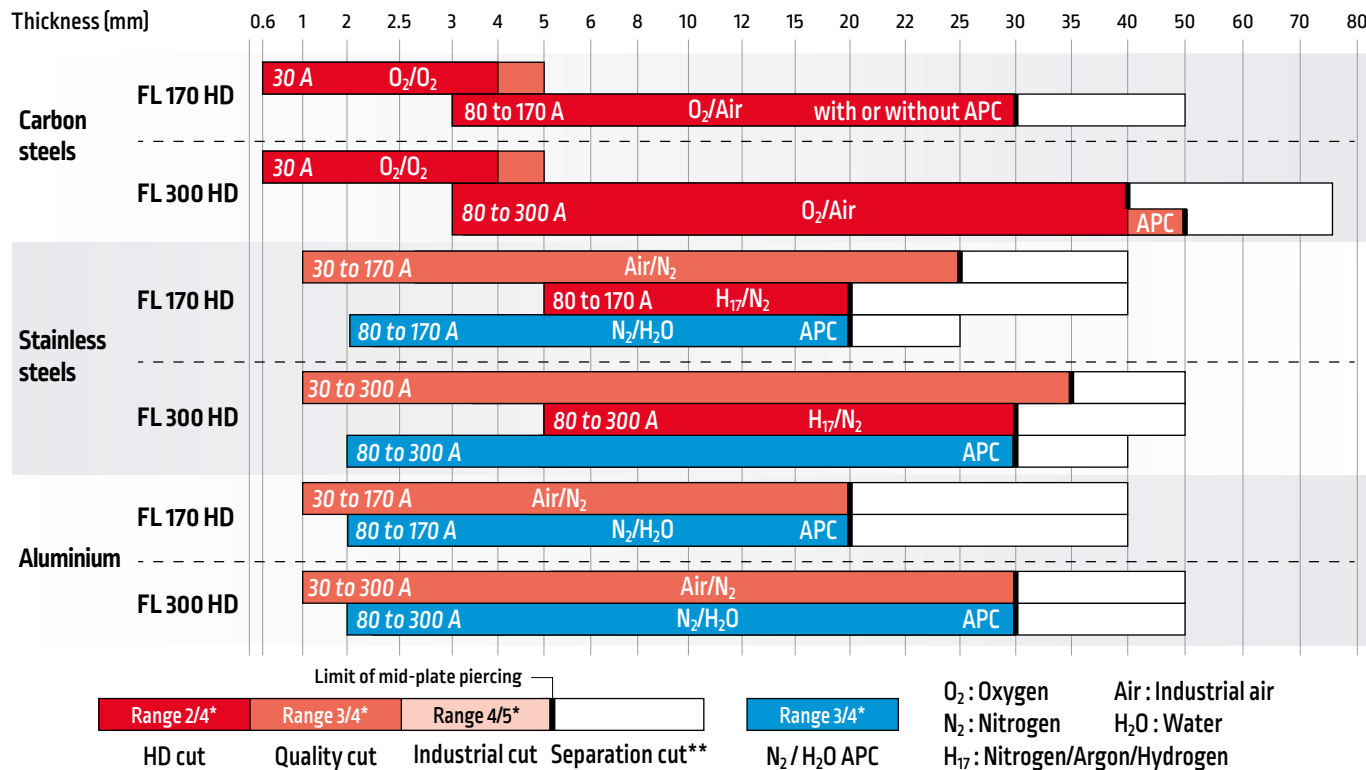

	FineLine® HD 170	FineLine® HD 300
Input Power Voltage/Phase/Hertz	380/415 - 3 ph 50/60 Hz	380/415 - 3 ph 50/60 Hz
Rated Output: Current / Voltage / @ 100%	170 A / 210 V	300 A / 210 V
Input Current	69 A	123 A
Output Range	20 - 170 A	20 - 300 A
Gas Required	Air/O ₂ /N ₂ (76-10 Bar) Optional: Ar/H ₁₇ (76-10 Bar) & H ₂ O (2.8-8.6 bar)	

* following ISO9013, standards for classification of thermal cuts - ** informative values not present in the HPC database

NERTAJET HPI 450 & 600A

High Power Cutting Plasma

Installations designed for heavy thickness from 1 to 150 mm or plasma beveling application

Everything has been designed on this system to work in the roughest conditions while guaranteeing optimum cut quality and ease of use, thanks in particular to its integrated data base and its removable torch nose with simplified assembly of consumables.

This cutting tool is used to obtain the following:

- Dimensional and geometrical accuracy of the pieces cut on a wide range of materials
- Quality of the surface of the cut faces (*roughness far below than that of a laser*)
- A cut angle (*range 2 to 4 in accordance with ISO 9013*)
- Holes with a remarkable straightness on carbon steel with **HOLE MASTER**
- Cuts with no adhering slag
- Reducing operating cost thanks to the high cutting speed associated with advanced **CYCLE BOOST** and **INSTANT MARKING** functions
- Quality maintained thanks to the optimized life time and wear compensation function **CDHC** of plasma components
- Compatible with EN1090 requirements

Composed in particular of:

- Dual Gas torch HD CPM400 for quality cut on all material up to 50 mm,
- New plasma removable torch head CPM PRO INOX:
 - Design to cut up to 150 mm
 - Dual injection process dry gas or with water vortex
 - No setting, just mount your consumables and cut
- New advanced function POWER HIGH Thick for plate piercing up to 110 mm in full automatic

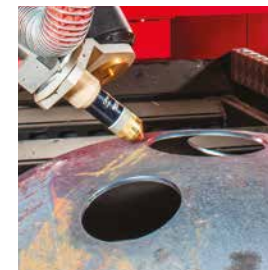

NERTAJET HPI 450 & 600 CPM400 Black et CPM PRO INOX

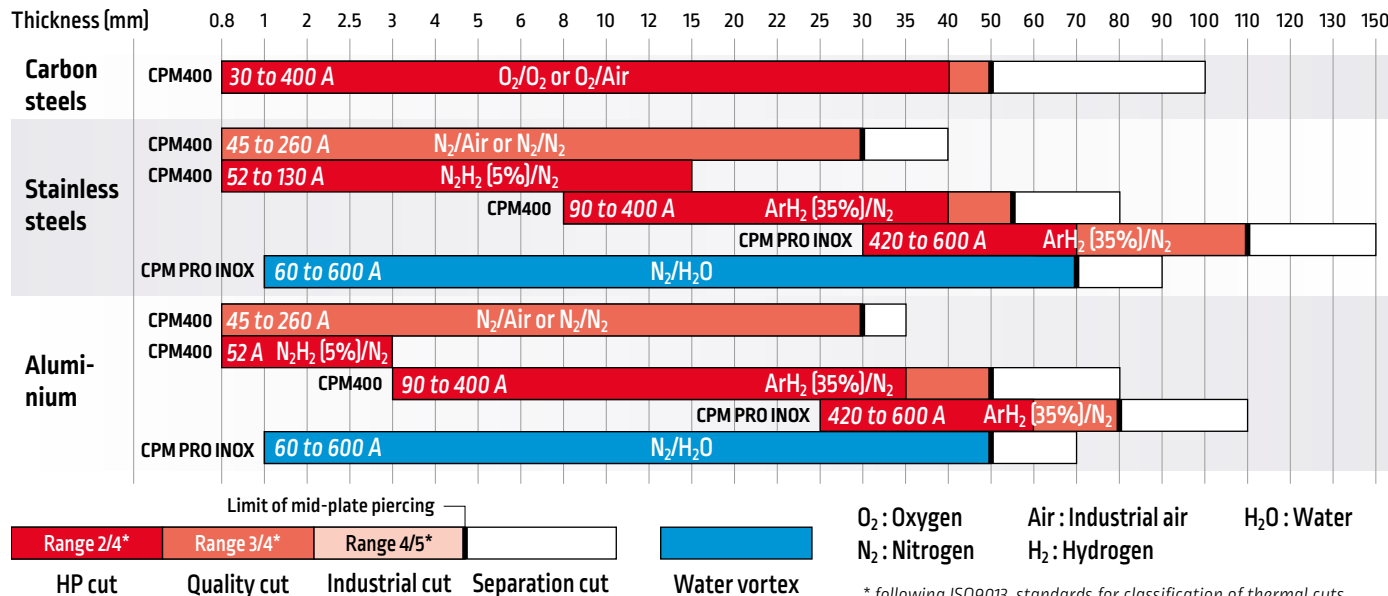

NERTAJET HPI SPECIFICATIONS

	NERTAJET HPI 450	NERTAJET HPI 600
Input Power Voltage/ Phase/Hertz	230/400/440 V - 3 ph - 50/60 Hz	
Rated Output: Current / Voltage / @ 100%	450 A / 230 V	600 A / 230 V
Input Current	308/189/164 A	415/247/217 A
Output Range	8-450 A	8-600 A
Gas Pressure Required	9 bars	

OXYCUTTING RANGE

A large range of oxyfuel cutting torches with performance and flexibility

For oxycutting of non or low alloyed steels from 3 to 300 mm, Lincoln Electric offers a full range of oxyfuel cutting torches: OXYCUT MACH, MACH HP or MACH HPI to install on fully automatic machines [gantry machines type OXYTOME].

MACH HP & MACH HPI

Tool free nozzle change

Thickness 6 to 300 mm

High speed cutting nozzles

System OxyCOOL

Heating oxygen / combustible gas mixture
Cutting oxygen channel
Flow of cooling oxygen
Cutting nozzle
Flame & heat Projections
Heating flame
Plate

Type of cut

Thickness (mm)	MACH HP (mm/min)	Conventional torch (mm/min)	Mid-plate piercing limit (mm/min)
10	700	600	550
25	550	450	400
40	450	350	300
60	350	250	200
100	250	150	150
150	180	100	100
200	130	80	80
250	100	70	70
300	80	60	60

* average speed multi-gas



OXYCUT MACH HP

- Cutting capacity 6 to 300 mm
- Productivity
- Cutting quality
- Fitting of consumables without tools: easy & quick
- Lifetime
- Piercing up to 150 mm



OXYCUT MACH HPI

- Internal ignition
- Cutting capacity 6 to 300 mm
- Productivity
- Cutting quality
- Fitting of consumables without tools: easy & quick
- Lifetime
- Piercing up to 150 mm



Systems of gas regulation fully controlled by HPCIII with full automatic cycle:

	OXY Essential	OXY HPI2
Number of torches	4 (1 module of 4)	8 (up to 2 modules of 4)
Gas regulation	Automatic gas	
Maximum thickness: Cutting / Piercing	200 / 150 mm	300 / 150 mm
Tool holders	150 mm stroke	Yes
	250 mm stroke	-
	Cable chain	Yes
	Speed	2 m/min
Oxy torches	MACH HP	✓
	MACH HPI	✓
Fixed electric ignitor*	Option	-
OXY SAFE PIERCING - Including choc sensor (Probe detection) [igniter* and retractable probe]	Option	Standard
Beveling tool with tilting nozzle**		✓
Strip cutting tool**		✓
VXK cutting tool	1	2

Fully managed by HPC III



* integrated ignitor with MACH HPI

** use without capacitive probe & automatic ignition

CUTTING MACHINES RANGE

A wide range from the simple mechanised carriage to fully automatised large capacity machines, from torch for straight cut to the 3D plasma cutting tool.

The complete offer of Lincoln Electric can answer to all your cutting needs with oxycutting and/or plasma process.

The various tools and options will enable you to produce parts with shapes, with or without bevel for occasional use or intensive production, on small or large format sheet metal.



Portable carriage



EUROTOME²

OPTITOME²

LINC-CUT[®] S



MAIN OPTIONS



• Tube cutting



• Beveling



• Drilling

Main characteristics, equipment and options

MACHINES	Transversal stroke							Useful longitudinal stroke	PLASMA [maximal number]			OXY [maximal number/thick]		Main technological options			Table				
	1m	1,5m	2m	2,5m	3m	3,5m	4m		4,5m	5m	5,5m	6m	...	Air	High Precision	High Power	Auto	Tube	NERTAJET BEVEL HPI	Numerical Drilling unit	Water
LINC-CUT [®] S									2 to 3	1	-	-	-	-	-	-	-	-	-	X	X
OPTITOME ²									1 to 6	1	1	-	1/50 mm	X	-	-	-	-	-	X	-
PLASMATOME ² HD									3 to 24	-	2	-	1/100 mm	X	-	-	-	-	-	X	X
EUROTOME ²									3 to 15	2	1	-	4/200 mm	X	-	-	-	-	-	X	X
OXY/PLASMATOME ²									3 to 32		2		8/300 mm	X	-	-	-	-	-	X	X
OXY/PLASMATOME TWIN									3 to 32		2		6/300 mm	X	X	-	-	-	X	X	X

LINC-CUT® S

Compact plasma cutting table

Boost your responsiveness and free your creativity

The concept of the LINC-CUT® S range is to offer an affordable plasma cutting machine to reinforce your creativity, your reactivity and to cover your production needs. The main features are:

- Fast and simple set up concept
- Easy to use
- An intuitive 20" touch screen HMI with an integrated 36-part shape library will get you cutting immediately
- The 4 numerical axis are equipped with ball bearing railways to provide fluid movement and increase cut quality
- The machine is supplied with a software package to be installed on your PC to import formats .dxf, .dwg to draw pieces, to nest and generate machine programs
- A laser spot simplifies the alignment of sheets
- Through the TOMAHAWK® 1538 or the FLEXCUT® 125 technology with compressed air, the machine produces a high level of quality for the cutting with cost efficiency:
 - High life time
 - Reduce post process operations
 - Less dross and better edge quality



	LINC-CUT® S 1020w	LINC-CUT® S 1530w	LINC-CUT® S 1530d
Plate format	1000x2000 mm	1500x3000 mm	1500x3000 mm
Machine size l x L x h	2400x3200x1600 mm	2400x4200x1600 mm	2550x4500x1400 mm
Table technology	Water	Water	Down draft table (5 sections of 650 mm)
Max plate load	355 kg	710 kg	1500 kg
Max scraps capacity	100 kg	200 kg	1000 kg
Carbon steel and stainless steel	✓	✓	✓
Aluminium	✗	✗	✓
Filtration technology	Water	Water	DIGIFILTER
Exposition to plasma cutting gases	Yes - Depends of the size of the workshop, the renewal of the air and the material to cut		No



	TOMAHAWK® 1538	FLEXCUT® 125
Plate piercing	20 mm	25 mm
Edge	30 mm	40 mm

LINC-CUT® S 1020w or 1530w

Water table concept

Machine frame consist in a strong table with water mixed with liquid, makes it possible to capture the dust released during cutting. The benefit of this system is to be simple to install and fast to run in production. It requires special attention on the implementation in order not to exceed the limit values of the gas generated: workshop volume, ventilation and materials to be cut.



LINC-CUT® S 1530d

Down draft table version

The table has several compartments that helps extend the effectiveness of extraction.

Each compartment has air diffuser boxes:

- To protect the sides of the table from heating
- To protect the air extraction opening hatches
- To collect the cutting slag or pieces

Associated with a DIGIFILTER 4CD, the assembly allows production without limitations.



OPTITOME²

Monobloc plasma cutting machine: robust, versatile and efficient

This machine is designed for use with FineLine[®] HD plasma installations to achieve very high cutting quality. Its single-piece construction is highly sturdy, allowing simple and quick assembly. This machine can handle heavy-duty production work, up to 300 A.

FineLine[®] HD: the new generation of high-precision plasma installations developed by Lincoln Electric, with advanced functions:

- CYCLE BOOST and INSTANT MARKING: for shorter production times
- ULTRA SHARP 2.0 and CDHC: for improved cutting quality

Main technical characteristics:

- Max travel speed in jog 21.2 m/min, 15 m/min in production
- Brushless motorisation guaranteeing accuracy and fluidity of movement
- Beam height to place rectangular pipes up to 200 mm high
- Absolute encoders



The table has compartments at every 650 mm that helps extend the effectiveness of extraction.

Each compartment has air diffuser boxes:

- To protect the sides of the table from heating
- To protect the air extraction opening hatches
- To collect the cutting slag or pieces

Version	1530	2010	2040	2060
Cutting width (mm)	1500	2000	2000	2000
Cutting length (mm)	3000	1000	4000	6000
Total width (mm)*	2504	3050	3050	3050
Total length (mm)*	4375	2550	5325	7380
Total height (mm)*	2000	2000	2000	2000
Max thickness	50 mm			

* excluding safety zone and equipments (plasma power source, filter, etc...)

Plasma process	
Number	1
Type	FLEXCUT [®] 125 FineLine [®] HD 170 FineLine [®] HD 300
Main options	
1 oxy essential Marker Wen, tube cutting, positioning laser	

PLASMATOME² HD

High precision plasma cutting machine:
high quality, robustness and productivity

High quality plasma cutting requires more and more precision. The **PLASMATOME² HD** allows cutting and marking by plasma process on non-alloy or low-alloy carbon steel, stainless steel and light alloy plates with a thickness from 0.5 to 100 mm.

The linear guideline systems fully protected, the lowered tracks and the separated console is giving fluidity of movement and dynamism make a machine specially designed for HD plasma cutting at intensive use.

Main technical characteristics:

- Max travel speed in jog 21.2 m/min, 15 m/min in production
- Numerical control by HPCIII digital process: management and control fully automated of plasma processes
- Brushless motorization ensuring accuracy and fluidity of movement
- Linear guides
- Absolute encoders

"A la carte" version	15	20	25	30	35	40	45
Cutting width [mm]	1500	2000	2500	3000	3500	4000	4500
Cutting length [mm]	3050+R						
Total width [mm]*	2890	3390	3890	4390	4890	5390	5890
Total length [mm]*	5981 + R						
Total height [mm]*	1662						
Max thickness	100 mm						

R = additional rail of 1.5 m or 3 m / useful travel maxi = 24 m

* excluding safety zone and equipments (plasma power source, filter, etc...)

Cutting tool	
Number	Up to 2
Type	FineLine [®] HD 170 FineLine [®] HD 300 NERTAJET HPI 450
Main options	
Visio Process, 1 Oxy essential MACH HPI with internal ignition, max thickness 100 mm, Cut of tube, Capacitive sensor OXY SAFE PIERCING, Micro percussion marker, Cutting table lighting, 4 th axis, Additional rail 1.5 m or 3 m (max useful stroke = 24 m).	



EUROTOME²

Thermal cutting machine: easy to use, versatile and cost-effective

EUROTOME²: a rugged mechanical machine design which brings together all the necessary qualities for the implementation of oxycutting, plasma and marking processes.

Equipped with the HPC numerical control with an high quality touchscreen, the EUROTOME² fits to all fabrication needs from the lowest thickness (0.5 mm) to the most important with all processes (oxyflame cutting and/or plasma).

Its concept is versatility, **EUROTOME² can be equipped with various tools**: 1 to 4 oxyfuel torches managed by OXY Essential, a plasma installation (FLEXCUT[®] 125 CE or FineLine[®] HD 170 or 300), a marking tool and a VXK bevelling tool.

The various sizes of beam width (sizes 15, 20, 25, 30 & 35) and length of railway (original rail effective travel 3 m can be extended with 3 m or 1.5 m modules).



Main technical characteristics:

- Max travel speed in jog 21.2 m/min, 15 m/min in production
- Brushless motorisation with absolute encoders ensuring accuracy and fluidity of movement
- Separate table on the machine frame
- Managed by HPC digital process

"A la carte" version	15	20	25	30	35
Cutting width (mm)	1500	2000	2500	3000	3500
Cutting length (mm)	3050+R				
Total width (mm)*	3300	3800	4300	4800	5300
Total length (mm)*	5580+R				
Max thickness	200 mm				

R = additional rail by modules of 3m or 1.5m

* excluding safety zone and equipments (plasma power source, filter, etc...)

	Plasma process	OXY process
Number	2	up to 4
Type	FLEXCUT [®] 125 FineLine [®] HD 170 FineLine [®] HD 300	OXY Essential with: MACH HP MACH HPI

Main options

Pneumatic marker, straight bevelling block VXK, tube cutting, automatic igniter, capacitive sensor, cabinet cooling by vortex, positioning laser.

Compatible with standard EN ISO 17916: 2016

OXYTOME² & PLASMATOME²

Thermal cutting machine completely automated, robust, versatile and efficient

The OXYTOME² / PLASMATOME² range integrates all the features required to implement the plasma and/or oxycutting process. These machines are suitable for all trades using plasma and oxycutting. Their concept is versatility and a wide choice:

Plasma installation in single or bi torch:

- FineLine[®] HD 170 or 300
- From NERTAJET HPI 450 to 600A
- FLEXCUT[®] 125 CE

Oxy installations:

- Full automatic management of oxyfuel process thanks to OXY Essential or OXY HPI2 systems depending thickness capacity needs

Applications:

- Cut from 0.5 to 300 mm thickness low alloy steels or non-alloy steels
- 150 mm thickness stainless steel
- 130 mm thickness light alloys

Uses:

- Dry plasma cutting to immersed plasma cutting, cut of tubes and domes



Main technical characteristics:

- Max travel speed in jog 21.2 m/min, 15 m/min in production
- Double motorisation with absolute encoders
- HPC digital process: management and control fully automated for plasma and oxycutting process
- **OXYTOME² HPI** can receive up to 6 tools (6 OXY or 4 OXY and 2 plasma)
- **PLASMATOME² HPI** can receive up to 2 plasma installations

"A la carte" version	15	20	25	30	35	40	45	50	55
Cutting width (mm)	2065	2565	3065	3565	4065	4565	5065	5425	5925
Cutting length (mm)	3350+R								
Total width (mm)*	3500	4000	4500	5000	5500	6000	6500	6920	7420
Total length (mm)*	6200+R								
Max thickness	300 mm								

R = additional rail by modules of 3 m or 1.5 m / useful travel 30 m maxi.

* excluding safety zone and equipments (plasma power source, filter, etc...)

	Plasma process	OXY process
Number	up to 2	up to 8
	6 tools maxi	
Type	FLEXCUT [®] 125 FineLine [®] HD 170 FineLine [®] HD 300 NERTAJET HPI 450 NERTAJET HPI 600	OXY Essential or OXY HPI2 with: MACH HP MACH HPI

Main options

NERTAJET BEVEL HPI, cut of tube, micro percussion marker, laser positioning, 4th axis, automatic indexing, straight bevelling block VXK, camera, aerial cable chains, 25 m/min production speed, cutting table lighting.

OXYTOME & PLASMATOME TWIN

Robust high-precision machines in medium and large format for thermal cutting with fully automated control.

The OXYTOME / PLASMATOME TWIN range is proposed in medium and large format. It fits all trades for the lowest thicknesses (0.5 mm) to the largest accessible for plasma and / or oxycutting.

Its linear guideline systems fully protected, double beam concept, fluidity of movement and dynamism make a machine specially designed for plasma or OXY HPI2 cutting at intensive use. It is perfectly adapted to implement bevelling applications all automated.

Combined with one or more torches, it provides versatility cutting applications and cuts of high quality.

Full automatic management of oxyfuel process thanks to OXY HPI2 system.



Main technical characteristics:

- Max travel speed in jog 21.2 m/min, 15 m/min in production
- Traditional longitudinal railways or fully protected longitudinal linear railways in option
- Brushless motorisation with absolute encoders ensuring accuracy and fluidity of movement
- HPC digital process: management and control fully automated for plasma and oxycutting process
- **OXYTOME TWIN** can receive up to 6 tools
- **PLASMATOME TWIN** can receive up to 2 plasma installations
- Double beam transverse with roller bearing

"A la carte" version	30	35	40	45	50
Cutting width (mm)	3425	3925	4425	4925	5425
Cutting length (mm)	4535+R				
Total width (mm)*	4920	5420	5920	6420	6920
Total length (mm)*	6200+R				
Max thickness	300 mm				

Traditional railways: R = additional rail of 1.5 m or 3 m / Useful travel maxi = 32 m
Linear railways (option): R = additional rail of 2 m or 3 m / Useful travel maxi = 24 m

* excluding safety zone and equipments (plasma power source, filter, etc...)

	Plasma process	OXY process
Number	up to 2	up to 6
	6 tools	
Type	FineLine® HD 170 FineLine® HD 300 NERTAJET HPI 450 NERTAJET HPI 600	OXY HPI2 with: MACH HP
Main options		
NERTAJET BEVEL HPI, cut of tube, micro percussion marker, laser positioning, 4 th axis, automatic indexing, straight bevelling block VXK, camera, aerial cable chains, drilling unit, 25 m/min production speed, cutting table lighting, fully protected longitudinal linear railways in option		

CUSTOMISED CUTTING MACHINE

LINCOLN ELECTRIC AUTOMATION meet the needs of customers by offering special machines suitable for the most diverse and unusual applications. Large-size cutting machines, tube cutting with loader, automatic evacuation system for cut tubes, bevel cutting on tubes, non-standard formats, adaptation of fume extraction systems.

Our special projects use a range of standardised equipment, including common components such as the FINELINE® HD or HPCIII numerical controller.

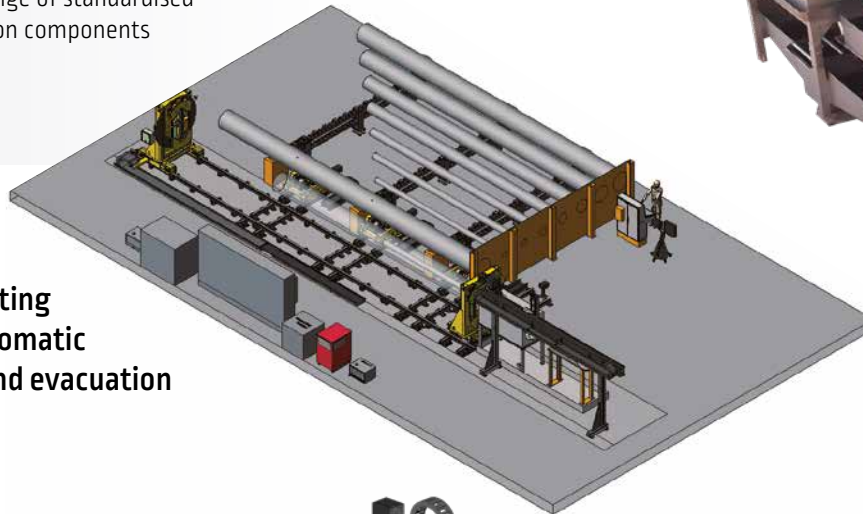

Tube cutting with automatic loader and evacuation

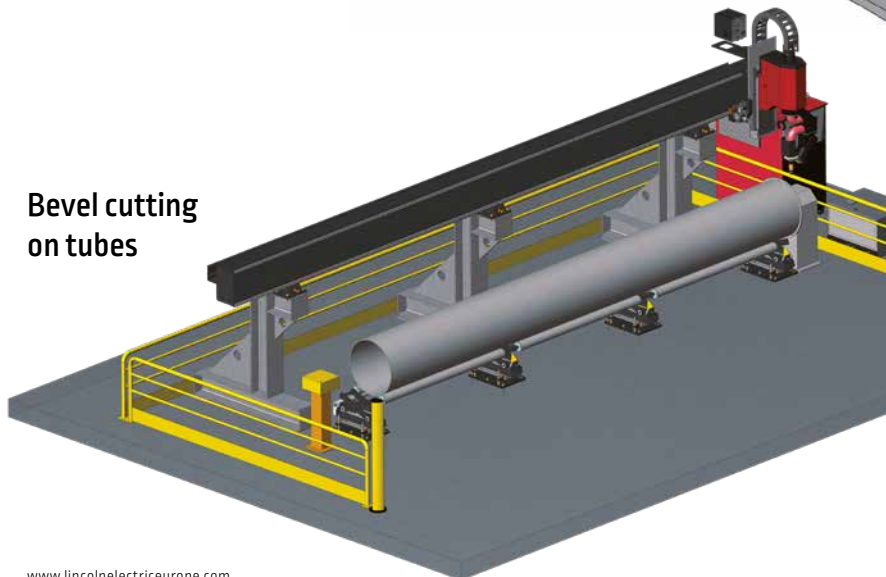
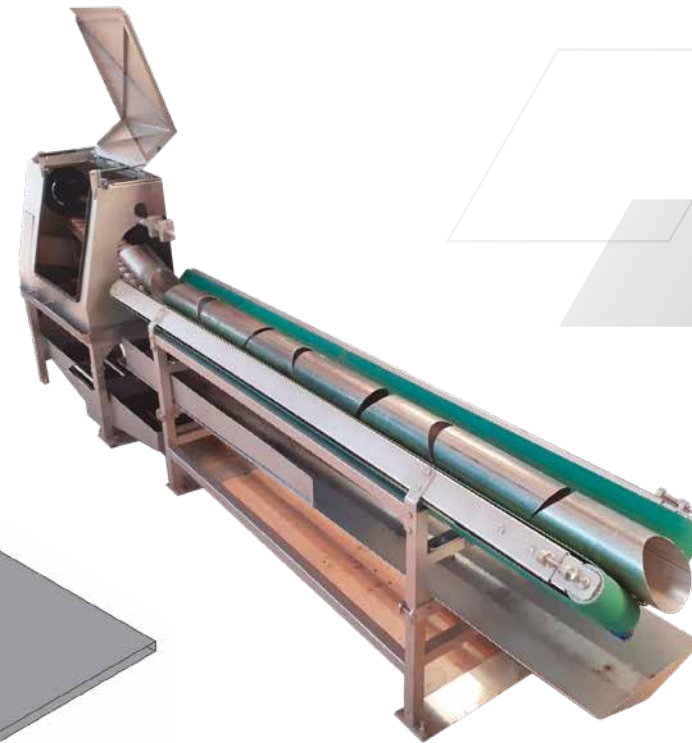

Bevel cutting on tubes



Extra large dimensions with on-board operator



HPC DIGITAL PROCESS III

Intuitive, automatic, educational

The most intuitive and efficient numerical control on the market.

It fully manages the cutting machine, from the trajectory to the processes.

The ergonomics of the HMI and its large 22" 16/9 touch screen make it a user-friendly and easy-to-use tool. All has been design to be intuitive but also educational with different diagrams integrated explaining simply how to use.

In particular, it includes all the important functions suited to the thermal cutting business such as: Cutting recovery menu, parametric shapes, sheet metal alignment, test menus, automatic adjustment of parameters...

The features of HPC III:

- 66 Parametric forms with cutting quality management. Possibility to add customized shapes to the customer's needs
- Iso code editor
- Scale, rotation, symmetry
- Choice origin program
- Management of sheet metal works
- Sheet metal alignment assistance tool 2 or 3 points methodology
- SMART DATA BASE with up to 10 qualities per parameter. Includes an lead in & lead out strategy for bolt holes
- Plasma and flame cutting processes
- Controls of processes
- Dynamic visualization of the part and tracking of the trajectory in real time
- Skeleton cutting function by learning
- Function to extract a part from a nesting
- Smart plate detection function
- Program recovery menu: forward/backward on trajectory, offset for restart of the off trajectory cut, zoom
- Complete setup for machine configuration: Tools, Options, Languages
- Options: Tube cutting, 2nd digitized transverse axis, automatic indexing, visio-process, laser positioning or measurement, fume extraction "DIGIFILTER Inside" management
- NERTAJET BEVEL HPI, digital drilling *[this options can be offered with version 1 or 2 of HPC]*
- 17 languages available



Hardware & Communication:

- Robust industrial computer Windows 10
- SSD hard drive with large capacity
- Real-time trajectory management system
- EtherCAT bus management
- 22" 16/9 industrial touch screen
- USB, NETWORK & TELESERVICE

How does the automatic adjustment of processes work on HPC III ?

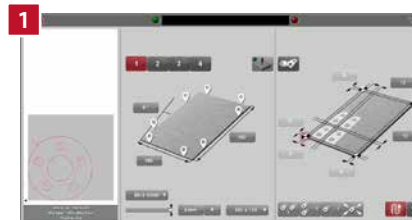

1 Program selection material, thickness, sheet format

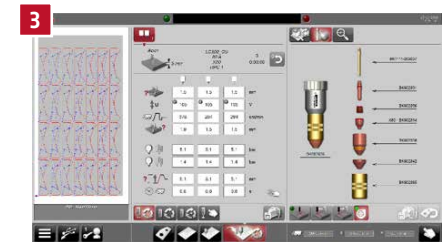

3 The adjustment of all parameters is done automatically

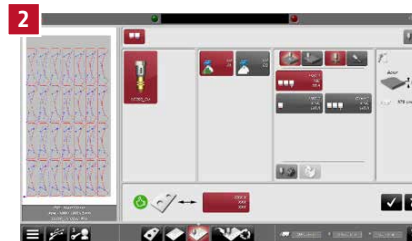

2 HPC III offers one or more cutting solutions



4 ULTRA SHARP2 function integrated database offering up to 10 cutting qualities

You can chose to use the data base of HPC or to create your own data base. JOB function gives you the possibility of attaching this process management to a program loaded and selected in the numerical controller. This combination can be stored by the JOB function and then used by any operator.

Advanced or Essential control panel:

The Advanced swivel console is equipped with a joystick, ergonomic manual controls, a maintenance mode to simplify the use of the machine and is found on the OXYTOME[®] and PLASMATOME[®] range.

Also available as a fixed console version on OPTITOME[®] and PLASMATOME[®] HD.

The Essential swivel Desk is fully touch-sensitive and equipped with a maintenance mode that simplifies the use of the machine.

It is found in particular on the EUROTOME[®] range.

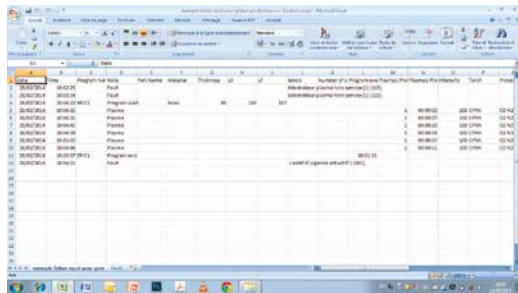

Quality cutting management

HPCIII manages up to 10 cutting qualities per parameter, including the cutting lead in and lead out. This controls hole diameter cut quality.

Production monitoring on HPC

A module dedicated for production monitoring, the HPC saves all actions undertaken during production. These files can be edited with Excel or can be automatically analysed by CAD/CAM software, and then saved on a USB key or directly on a customer directory if the CNC is connected on their network.

Data available:

- Number of cuts, time of cutting
- Material and process chosen
- CNC default
- Failed cut part
- ...

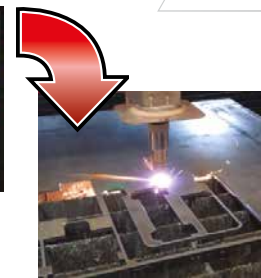
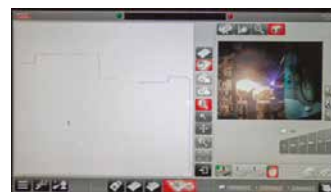

Skeleton cutting function by learning

HPCIII manages up to 10 cut qualities per parameter including the cutting lead in and lead out and allows control of the cut quality on all hole diameters.

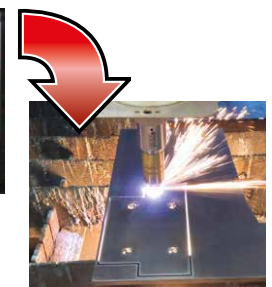
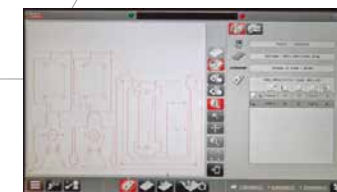

Function to extract a part from a nesting

Should a part have not been correctly cut on your nesting, HPCIII is able to extract the part from the nesting and cut it again.

CUTTING SOFTWARE



A well adapted software help increases the automation and the return on investment of machines fitted with the CNC. Lincoln Electric can supply software specially designed for thermal cutting CAD, pressure vessel shapes developed flat, interleaving, plate stock control, communication, translation of external files and files produced by other CAD systems [DXF, DWG, DSTV...].



Software for small and medium industries

Range of software designed for quick learning and adapted to the needs of small and medium-sized structures

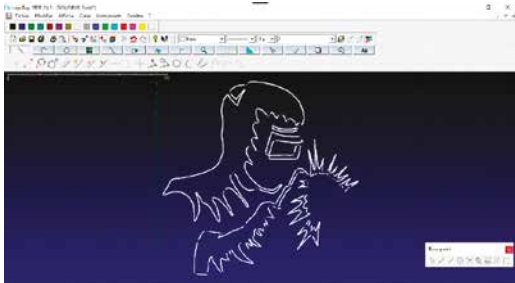
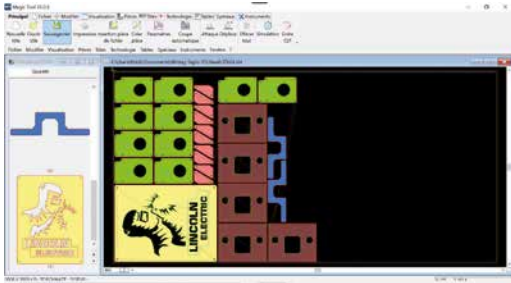
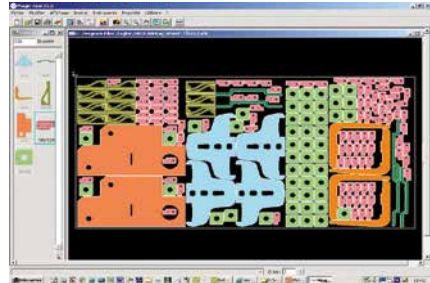
LINC CUT CAD CAM Software suite dedicated for LINC-CUT® S range	LINC CUT CAD CAM + Software suite dedicated for HPC CNC	MAGICNEST 10 Software suite for all CNC
		
Drawing module	Drawing module	Drawing module
Importation of dxf / dwg / dstv...	Importation of dxf / dwg / dstv...	Importation of dxf / dwg / dstv...
Lettering tool	Lettering tool	Lettering tool
Vectorization tool	Vectorization tool	Vectorization tool
Nesting module: manual, matrix or automatic	Manual or matrix nesting module & tools path	Automatic nesting & tools path module using best strategy for maximizing material savings
ISO codes programs generator for machine range LINC-CUT® S [VMD CNC interface]	Codes programs generator for different CNC machine: HPC, BURNY, VMD...	Codes programs generator for different CNC machine: HPC, BURNY, VMD...
-	-	Multi-torches, bridges, micro junction, pre-piercing, common cutting, scrap recovery...
-	-	Quotation tool
-	-	Plate storage management
-	-	Remaining scrap plate management

Software for medium and heavy industries and high range applications

Range of software designed for medium and heavy industries with powerful functionalities and different modules to manage advance applications like beveling, numerical drilling, tube cutting...

MAGICNEST EXPERT PLUS

This is the best and complete version for machine with option bevel, indexing or piercing. Drawing and nesting functions are similar to MAGICNEST 10. With bevel option, MAGICNEST EXPERT PLUS control open-ended bevelling units that use plasma technology. It may be used for all types of bevel - V, Y, X and K - in multiple pass processes. Possibility to include duct module and special marking (*SIC marking or inkjet*) in option.



DUCT OPTION MODULE

Duct is a powerful module of MAGICNEST Expert Plus for calculating DUCT figures. Duct is designed in such a way that the user only has to follow the simple steps prompted by the system.

User simply has to select the figure to be developed, enter the required dimensions, and the figure will automatically be developed.

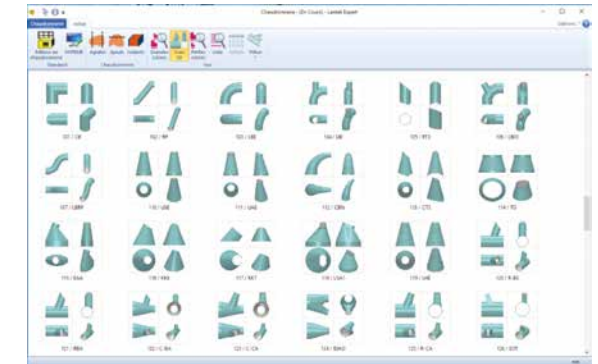

FLEX 3D

Flex3d Tubes is a member of the MAGICNEST Expert Plus family of products for the design and cutting of tubes.

Easy, flexible design Flex3D Tubes gives a real vision of the result on the screen.

It displays the exact tube and simulates in 3D.

Flex3D Tubes allows 3D design in an intuitive and simple way:

It gives the result that the user will obtain when cutting the profile on the machine.

It is a stand alone software available in 2 versions:

- Flex 3D tube: for only one reference part and one job
- Flex 3D tube +: auto nesting and warehouse management, for "mother bars" and remnants

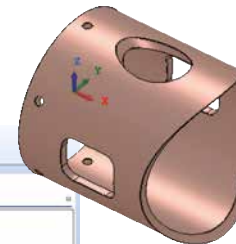
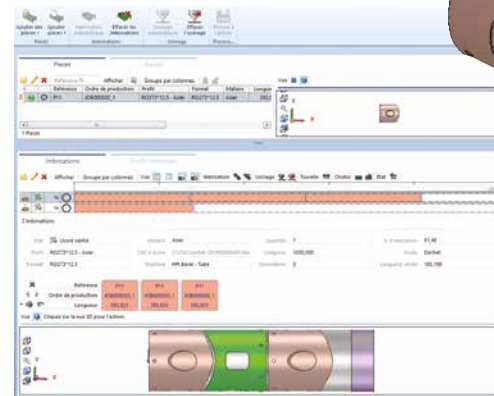

EXTRACTION TABLES

Extraction tables for dry cutting

The extraction tables with air extraction offers unrivalled efficiency in terms of fume extraction thanks to its unique system of transverse extraction ducts.

Robustly designed in one-piece or modular form, the table is divided over its length into multiple sections, extraction taking place across the full width of the table on the module in operation only.

Mechanical or pneumatic flaps actuated by the displacement of the machine provide suction under the sheet at the place of cutting only.

This principle of operation guarantees optimum extraction, irrespective of the size of the sheet being cut, while maintaining a modest extraction air-flow rate.

Technical characteristics:

- Transverse duct extraction system
- Division into 0.5 or 0.75 meter sections over the length of the table
- Removable slag boxes
- Removable workpiece supporting frame with flat iron [section 100x6 mm] and wire mesh grid [50x50x5 mm]
- Maximum capacity: sheet up to 300 mm thick



Variable water level tables

Variable water level tables are specifically intended for immersed plasma cutting.

This procedure limits pollution by solid or gaseous matter and gives protection against audible and visual stress.

It improves accuracy of cutting while limiting distortions caused by heating of the workpiece.

Technical characteristics:

- Modular construction in lengths of 1.5, 1.75 and 2 m
- Width: on request
- Pivoting workpiece support frame



Table with slag automatic outfeed

The table has an automatic cleaning system for evacuating slag, small scraps and parts.

The evacuation is done in containers which makes it possible to reduce the maintenance and the cleaning time of the table. The table has compartments and the machine selects the suction zone according to its position and thus makes it possible to obtain efficient fume and dust extraction.



Palletisable table

The palletization system allows loading and unloading of sheets to cut out of the cutting area.

The preparation of sheets to cut is performed in masked time without risks for the operator.

FUME EXTRACTION

When choosing a filtration unit several parameters must be taken into consideration:

- The quality of the filter elements, the structure of the filter media and the filtration performance
- The performance of the cleaning system of the filter elements
- To be able to control the flow-rate of the extracted air
- To be able to control the filter cleaning based on their level of contamination

The Digifilter is compact, all the elements are integrated.

Dust is collected on the PTFE membrane polyester filter cartridges.

The cleaning of the filter cartridges is done by compressed air, creating an instantaneous and brutal overpressure inside the cartridge allowing the unclogging of the fine dust.

The cartridges are therefore maintained in a good cleanliness, ensuring airflow always optimized.

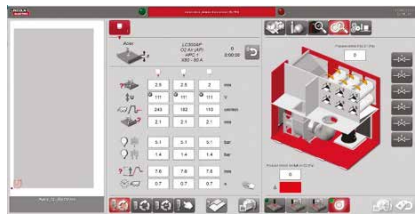

HPCIII DIGIFILTER Inside

DIGIFILTER 4CD, 6CD and 8CD are now fully controlled by HPCIII with interface **HPCIII DIGIFILTER Inside**.

On a single interface, the operator will be able to manage all his plasma or oxycutting operations and control or monitor the operation of the DIGIFILTER.

ROTARY LOCK with BIG BAG

This option allows the recovery of dust in Big-Bag.

The choice of recovery mode will be dictated by the daily volume collected and your ISO 14001 approach.

In Big Bag, once collected, the dust is no longer handled and the Big Bag is a validated container for transporting dust to pollutant treatment centers.



PUSH-PULL SOLUTION

This innovative system makes it possible to capture the fumes given off during cuts on the water table. Even if the majority of dust is captured by the table water, the gases and in particular the NOx, escape from the tables and must be extracted to not exceed the exposure limits.

This system therefore allows the smoke to be moved, captured and extracted from the building.

It is composed of:

- 1 A blowing ramp
- 2 A suction ramp
- 3 Ducting
- 4 Rectangular collection duct with shuttle according to machine movement
- 5 Fan motor

Benefits:

- Our PUSH PULL system captures these gases while completely freeing the plasma cutting head
- Unlike conventional sensors surrounding the torch, our system is not vulnerable to splashes, flames and humidity given off during cutting
- The collecting area is much larger than a traditional hood



NERTAJET BEVEL HPI

NERTAJET BEVEL HPI is an efficient tool for all cuts that require particular preparation for welding, or any other applications requiring bevels. It thus makes it possible to make V, Y, X and K bevels in a large range of thicknesses and materials.



Precise and robust

- “Machined robot wrist” technology offering:
 - High positioning accuracy: 3 axes are used to ensure the inclination and orientation of the torch
- High robustness with low sensitivity to shocks:
 - High mechanical conception robustness base on rotation axis
 - The bottom of the arm is quite far from the plate and tilting parts
 - Multi-directionnal choc sensor with large clearance
- Fully controlled by digital control HPC BEVEL EtherCAT
- EtherCAT motorization with absolute encoders
- Compatible with NERTAJET HPI 300 & 450

AC System integrated intelligent database

- Integrated in the numerical control, AC System automatically corrects the paths to compensate the angular and dimensional deviations generated by the plasma cutting process
- Allows even when the requested chamfer is not known, to obtain a proposal of parameters defined by extrapolation of the existing data
- The intuitive & user-friendly IHM gives quick and easy access to the database to refine or create new operating points

Function CDHC [Cutting Digital Height Control]

- Allows control of torch height during cutting phases. It is particularly important for the respect of the dimensions of the parts and the quality of realization of the chamfers
- Automatically adjusts the torch position to always be at optimal height to generate the best cutting quality
- Automatically compensates the wear of plasma consumables especially the electrode. Without this compensation, the dimensions of the chamfered parts would derive of several millimeters

Advanced features NERTAJET HPI

- Cycle Boost and Instant Marking: to increase productivity
- Hole Master HPI to increase cutting quality
- Twin Detect for cutting on dished end

Function TSB [Trajectory Strategy for Bevel]

- Optimized cutting strategy for a excellent dimensional result
- Optimized learning cycle for accurate acquisition of sheet position
- Specific torch orientation cycle for multi-pass chamfers for optimum dimensional results

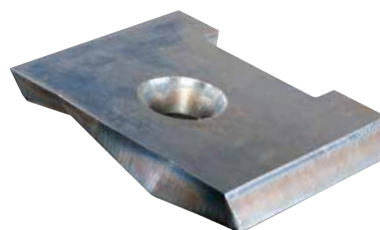

	PLASMATOME / OXYTOME TWIN
NERTAJET BEVEL HPI 300 or 450	✓

Type of bevel	V, Y, X and K Dimensional and angular accuracy according to ISO 9013
Rotation axis	+/- 455° 30 rpm/min
Tilt torch	+/- 52° 40 tr/min Allows cutting angles of up to 50°
Z axis slide	250 mm 5 m/min
Options	Tube cutting, cuts on dished end, Z axis slide of 800 mm, mechanical sensor for evolutive chamfering on standard plates

TUBE CUTTING

This option has been developed to meet many cutting applications on round tube from small to large diameter. Thanks to its software interfaces, the machine is able to cut different types of geometry on tube: stitching, cod mouth, separation cut, straight or evolutive bevel etc...

The option is composed of a cabinet control interconnected to the HPC DIGITAL PROCESS, of a motorised headstock with fume extraction duct and an adjustable positioning system according to the diameters of tubes. The positioning of the tube offers many advantages including that the cut piece remains in position after cutting thus avoiding potential risk to safety or damage.



Main technical characteristics:

- With standard motorised headstock:
 - Diameter 400 mm*
 - Length up to 6 m
 - Weight maxi of tube: 550 kg
 - Speed maxi: 30 rpm
- Central fumes extraction
- Tube positioning by cross rotators or tube rotators
- Others dimensions on request
- NERTAJET BEVEL HPI in option

* Other diameter on demand



4TH MOTORISED AXIS

Automatic adjustment of the distance between cutting tools done with two CNC axes.

This option can be managed automatically with the nesting software. Inside a same program, different distances can be adjusted between the two torches depending the parts sizes to cut.

This option is mainly used with plasma system but can also be adapted with oxy-fuel process. This option is fully managed by a very nice control interface.



NUMERICAL DRILLING UNIT

Drilling unit can be fitted on cutting machine to combine drilling, thermal cutting and marking in one operation:

- Sheet metal press system
- Tool length measure system
- Automatic tool exchanger

Fully interfaced with the HPC DIGITAL PROCESS System, the management of the drilling unit is simple and user friendly.

Fully automatic management of the drilling unit. Simple and user friendly database of parameters for drilling unit.

This database (*spindle speed, rotated speed, ...*) can be updated by the operator depending on the tool used.

Minimum and maximum sheet metal thickness depends on the application and cutting machine.

Material could be drilled: carbon, stainless steel and aluminium.

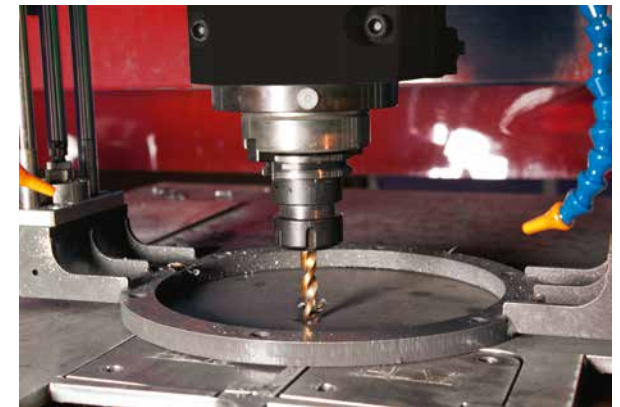
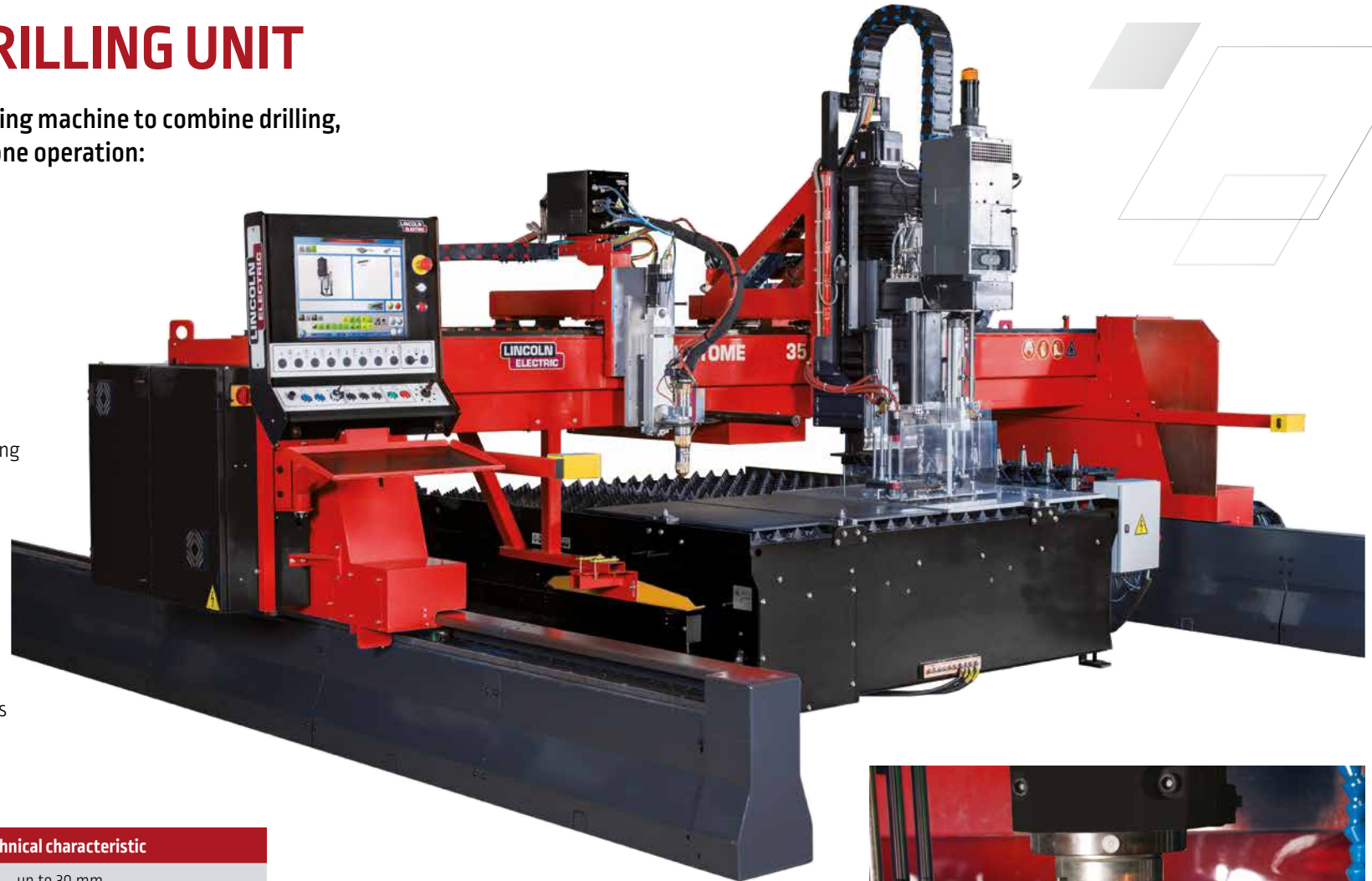

	Technical characteristic
Drill diameters	up to 30 mm
Tapping diameters	up to M18
Tool type	ISO 40
Lubrication	internal/external
Max. spindle motor power	up to 12 kW
Automatic tool exchanger	up to 20 tools
Machine compatible	OXYTOME / PLASMATOME TWIN / CYBERTOME

COMPLEMENT FOR MACHINE

Visioproces

A camera is used to display the torch position on a control screen.

The monitored area is about 250 mm in diameter and promotes correct positioning before and during cutting.

The device also monitors the arc.

The operator can control cutting operations and position the torch no matter where the control console is located.

The camera is protected by an anti-dazzle device to protect it from the effects of the plasma arc. The operator can choose between a monochrome or colour display.

Electrical cabinet

It can be equipped with air cooling system, heating system, voltage inverter to meet all requirements of environment.

Pneumatic or Wen marker

The 2 systems are mechanical engravers by percussion of the sheet metal using compressed air.

Combined with the movements of the machine, it is possible to create different types of texts, bending or welding mark etc...

The pneumatic version is recommended for marking on thick sheets from 15 mm, ideally combined with flame cutting. The Wen system is suitable for thin thicknesses from 3 or 4 mm. It allows to obtain a precision engraving particularly for text.

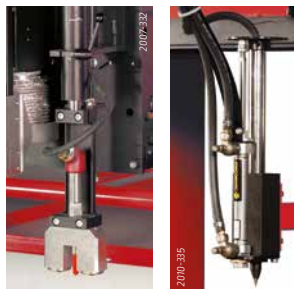

Operator visual protection

Curtain easy to adjust to protect the operator against the plasma electric arc.

Operator protection



Operator protection customizable depending on the implementation of the machine inside the customer workshop to ensure safety and be compliant with machine regulation.



Cutting table lighting

Lighting of the cutting table with 2 LEDs projectors placed on each side of the machine.



Micro-percussion marking

It allows a fast and accurate marking. This system can carry out several lines marking with small characters (*less than 10 mm*). To perform the marking, the micro marker box is automatically positioned above the sheet metal. Then it drives a pen following its 2 axes dedicated to draw characters and mark the sheet with the desired power (*marking depth*).



Positioning laser with greencross

Controlled by the interface of the HPC, this tool helps the operator to position the machine to start cutting program or make the alignment of the sheet metal.

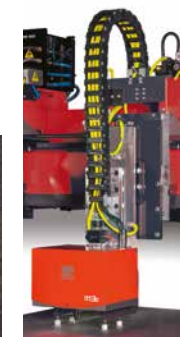

EQUIPMENT FOR OXYFUEL PROCESS

Bevel tool for oxyfuel torch

This tool easy to install and use gives the possibility to realize different kind of simple bevel following a straight line: standard V bevel or tapered bevel [bevel over 45° cut on plate edge].

Tapered bevel [bevel over than 45°]

This tool is well adapted to realize tapered bevel on plate edge with or without the assistance of a mechanical sensor to follow the distortion of the plate.



Beveling block V X K

For bevels parallel to the axes using mechanical sensors. It allow to work on thicknesses up to 70 mm.

The system is equipped with 3 short oxyfuel torches and give the possibility to realize V, Y, X and K bevels.

Each side oxyfuel torches can be adjust following an angle from 10 to 45°.

The two robust rollers of the mechanical sensor are cooling by compressed air. In option, the VXK can be fit on electrical tool holder with a quick mechanical exchanger. It gives the possibility to work with a standard straight cutting torch or with a VXK beveling block.

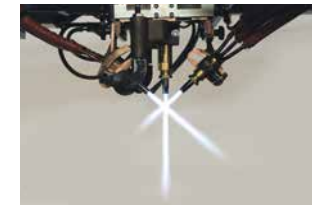

Strip cutting systems

Tools to realize strip cutting. Two systems are available: One system to fit directly on the oxy-fuel torch.

The system use two set of nozzles.

The distance between each other is adjusted by opening more or less the tool. Distance between the 2 nozzles: from 40 to 400 mm.

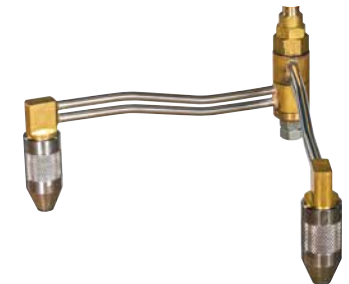

Set capacitive sensor/automatic ignition for OXY torch with OXY SAFE PIERCING

Proposed in the basic version on version on OXYTOME®, OXYTOME TWIN and in option on EUROTOME®, this unique system on the market, allows to retract during phases of piercing both the sensor and the igniter. OXY SAFE PIERCING authorizes mid plate piercing up to 150 mm thickness in automatic cycle without any disassembly of the probe or the igniter.

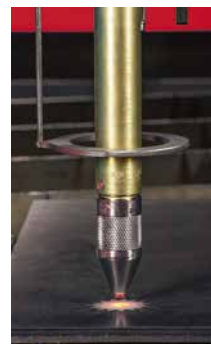

PYROTOME SE, the carriage on rails

The PYROTOME SE is a portable multiprocess carriage for straight or V bevel cuts. Its electronic speed regulation [10 to 125 cm/min] and robustness make it the indispensable tool for intensive use.

The PYROTOME SE basic version is equipped for oxycutting [plasma cutting on request].



PythonX STRUCTURAL

All in one solution for infrastructure segment

PythonX STRUCTURAL is the leading all-in-one robotic plasma system in the world trusted by more end-users with over 440+ systems installed worldwide.



This CE certified system takes in your drawing files and automatically processes beams, channels, angles, square and rectangular tubes, as well as plate, all on one machine. In addition, the machine produces bolt holes that are EN1090 compliant.

Additional cutting capabilities include copes, slots, cutouts, cut to length, miter cuts, weld preps, and scribe part/layout marks, all done in one place, eliminating countless hours of material handling in between operations.

Because everything is done on one machine, saving you valuable shop space, you'll be able to streamline your operations. PythonX STRUCTURAL allows you to automate structural steel fabrication operations in your plant, saving you time and money.

Simple to use

- 1 Load the raw part for processing
- 2 Open a part file on the HMI
- 3 Press start

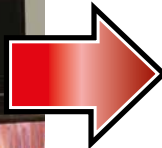

PYTHONX[®]

STRUCTURAL

Streamlining a path to more efficient production.



Efficiency is the key advantage when it comes to fabricating structural steel. Only a single operator and no programming are required to operate the **PythonX STRUCTURAL**.

PythonX STRUCTURAL delivers the advantage of completely finished pieces at the **LOWEST COST PER TON** versus your competitor's old technology.

How long would it take to fabricate this beam in your shop ?



- 13 bolt holes
- Web trim
- Flange notch
- 3 slots
- 9 letter piece marks
- 2 flush flange cuts
- 3 copes
- Miter cut/trim
- 4 layout marks

Only 4 minutes 26 seconds with PythonX STRUCTURAL

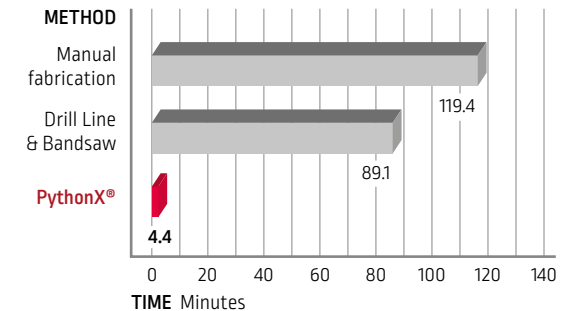

EN1090 compliant bolt holes

PythonX STRUCTURAL produces unmatched bolt hole quality eliminating the need for operator intervention and consistently outperforms competitive systems. Engineers around the globe can design with confidence knowing that plasma cut holes cut by PythonX STRUCTURAL can be used in a broad range of load applications* such as:

- Static
- Cyclic
- Seismic

** For complete details, refer to The PythonX[®] Guide to Plasma Cutting in Codes and Standards available from your local Sales Representative*



WELDING SYSTEMS



WELDING PROCESSES

TIG Technology

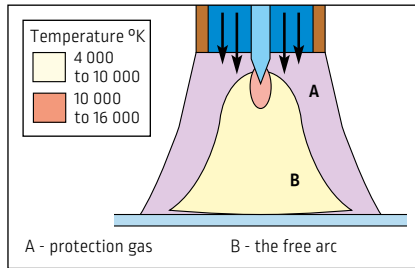

Metals are fused together by heating them with an electric arc. The electric arc is established between a non-consumable (*does not melt*) tungsten electrode and the workpiece. A filler metal may be used depending on the joint design. The molten metal is shielded from the atmosphere by a stream of inert gas supplied through the torch. The resulting deposited weld metal has the same integrity as the base material. This welding process is used for welding of carbon steel, stainless steel, aluminium, titanium, copper...

The benefits are:

- Good weld bead appearance
- Aluminium weldability
- Adapted for fine thickness
- Welding in all positions

TOPTIG Technology

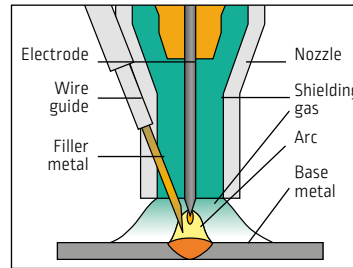

Based on principle of TIG process, an additional filler metal is fed through the nozzle directly into the arc with an angle of 20° to the electrode. This concept guarantees a high deposition rate and an efficient metal transfer. This welding process is used for welding of carbon steel, stainless steel, titanium, inconel, electro-galvanized coated steel (*brazing*)...

The benefits are:

- TIG high quality welding and guaranteed spatter free
- Good global productivity
- Excellent appearance of the weld bead
- Torch accessibility and welding in all positions

PLASMA Technology

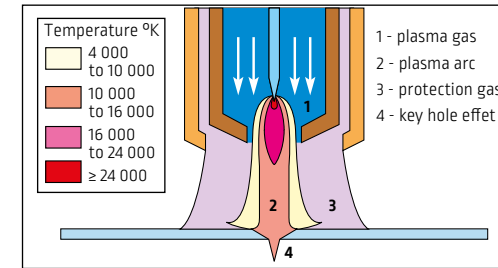

The contribution of energy necessary for welding is ensured by an electric arc in an atmosphere of plasmagene neutral gas. This arc established between an infusible electrode and the parts to be assembled is forced through a nozzle which constricts it mechanically and pneumatically. This welding process is used for welding of carbon steel, stainless steel, duplex, titanium, Inconel, nickel and alloys...

The benefits are:

- Reduction in the preparation times for assemblies by eliminating bevelling for thicknesses up to 10 mm
- Joint quality: Complete and regular penetration guaranteed, 100% X- ray quality
- Reduction of the heat affected zone thanks to the arc concentration
- Respect of the base material chemical composition
- Low distortion
- Reduction or elimination of finishing operations
- Excellent visual aspect

MIG/MAG Technology

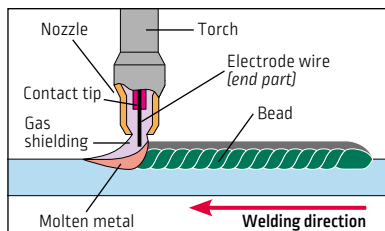

An electric arc forms between a consumable wire electrode and the workpiece (*metal*) which heats the workpiece metal causing them to fuse. The arc and weld pool are shielded by an inert or active gas. Metal is transferred in the form of drops through the arc towards the workpiece. This welding process is used for welding of carbon steel, stainless steel, aluminium, copper...

The benefits are:

- Easy implementation
- High welding speed
- Welding in all positions
- Low welding investment cost



SAW Technology

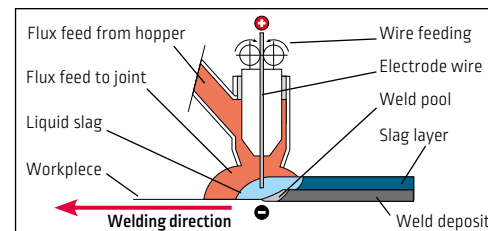

Similar to MIG/MAG welding, SAW involves the formation of an arc between a continuously fed wire electrode. Covering flux is used to generate protective gas and slag protecting the weld metal. The flux can also help donate alloying elements. It is dedicated mainly for flat and fillet welding. This process is generally used for the welding of materials as carbon steel and stainless steel.

The benefits are:

- High deposition rates
- High penetration
- Large execution speeds obtained by the use of high currents on one or more electrode-wires
- Excellent compact joints with good mechanical properties
- High duty cycle
- Operator comfort: low fumes and invisible arc



TIG & PLASMA

Applications

Multi-purpose welding installation to enable the following processes to be used in automatic applications:

- DC TIG with smooth or pulsed current
- AC TIG with variable polarity
- DC plasma with smooth or pulsed current

This installation meets the highest quality standards for welding and productivity for industries as diverse as boiler-making using stainless steels, aeronautics using precious metals, chemical engineering, energy production, transformation and transport as well as prefabrication of gas and petrol pipelines etc.



TIG / PLASMA process and performance

The Plasma process is the ideal extension of TIG for thicknesses greater than 3 mm.

It ensures the same level of quality, higher performances and 100% penetration thanks to Key-Hole technology. The diagram shows the different welding performances according to the materials and thicknesses.

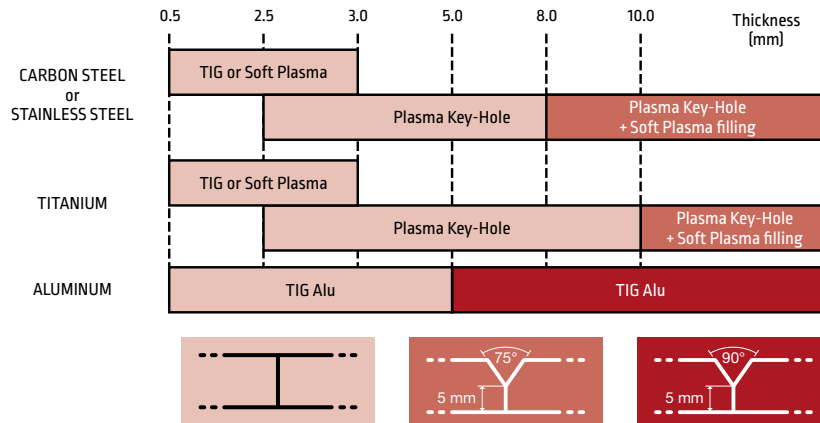

Maximum thickness which can be welded in a single pass is reduced for:

- vertical down and cornice (2G) welding positions
- small diameter and very thick tubes

Improvement productivity with PLASMA + TIG Process

The Plasma + TIG process is specially designed for assembling panels for the prefabrication of vessels longer than 4 meters and carrying out circular welds for diameters greater than 2 meters. This process of using 2 torches in tandem gives a productivity gain of 30-50 % over a single-torch plasma installation.

The "plasma" arc penetrates the butt-jointed panels. The "TIG" arc equipped with filler metal, electromagnetic arc oscillation and a gas trailing shield produces a perfect surface finish which can often be left without any further treatment.

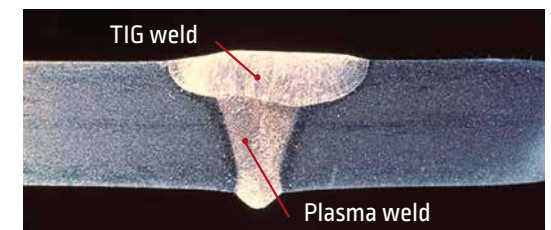
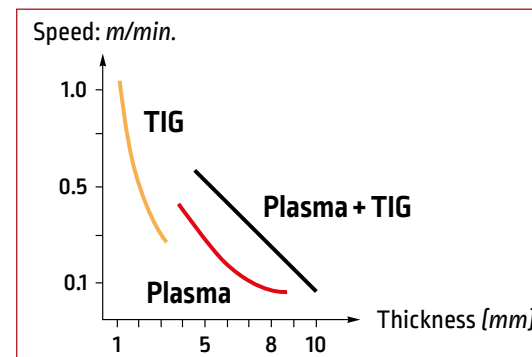
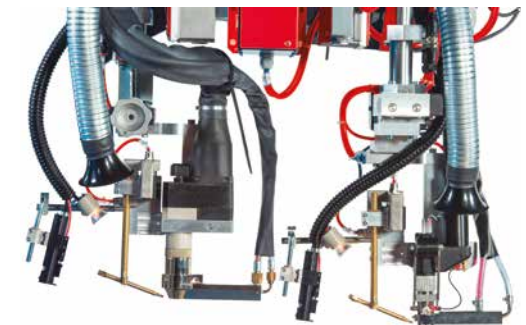

LINC-MASTER

TIG & PLASMA WELDING

Linc-Master installation for TIG, Plasma or Plasma+TIG powered by the Power Wave® S500.

A modern and compact design facilitates machine and retrofit integration.

The modular concept allows Linc-Master to be set in Plasma or TIG to accommodate the welding need.

- Modular design to fit with welding need
- Compact system for easy integration
- ECO design: Low primary consumption, excellent efficiency
- Management of welding functions such as current, wire, voltage, gases and welding speed

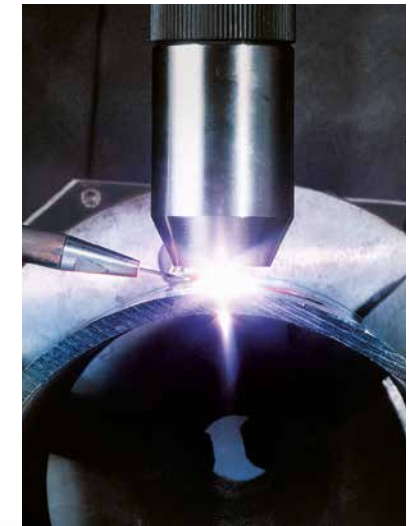

The **Power Wave® S500** is recognised for its automation application performance and lifetime. It is compliant with the latest European ECO design requirement so offers reduced power consumption coupled with greater efficiency.

This auxiliary source generates a pilot arc in plasma welding. The pilot arc current is adjustable from 5 to 25 amps and is controlled by the Linc-Master unit.

The **Advanced Module**, controlled by the Power Wave®, further expands welding capabilities adding TIG AC process using variable polarity.

The compact **FRIJET 300W** is used to cool down torches in heavy situations.

	Power Wave® S500
Primary supply	230-575 V / 3 ph / 50-60 Hz
Welding current - Duty cycle	5 to 450 @ 100%
Efficiency	87%
Hibernation	32.8 W

	Advanced Module
Max. current	300A @100%
Frequency	50 to 200Hz
Cyclic ratio	35 to 85%

	FRIJET 300W
Primary supply	230 V / 1 ph / 50-60 Hz
Pressure	5.5 bars
Nominal water flow rate	0.26 m³/h

TIG & PLASMA INSTALLATION

Multipurpose installation able to perform Plasma or TIG, DC or pulsed, TIG AC variable polarity.

HOT WIRE

Productivity improvement by increasing the deposition rate

Hot filler wire enables 2.5 to 3 kg of metal to be deposited per hour for filling bevels using multiple passes or for quality hard-surfacing. Hot wire is performed by additional power source to the wire feeding system delivering 10 to 200 A.



AVC SYSTEM

A constant distance between the torch and the workpiece is a key of quality to ensure a constant penetration and bead width.

The Arc Voltage Control (AVC) keep this constant distance by digital regulation of the arc voltage, function fully integrated into the Lincoln Electric system composed of an electrical vertical slide travel 200 mm.

VIDEO CAMERA

The TIG/plasma video system VISIOARC VA2 can be easily integrated. It uses a greatly enlarged image which enables the precise position of the welding torch. The operator can then work at remote distance of the welding head; working easier and improving the quality of the welding operations.



System with large color screen 15", miniaturised camera and additional lighting

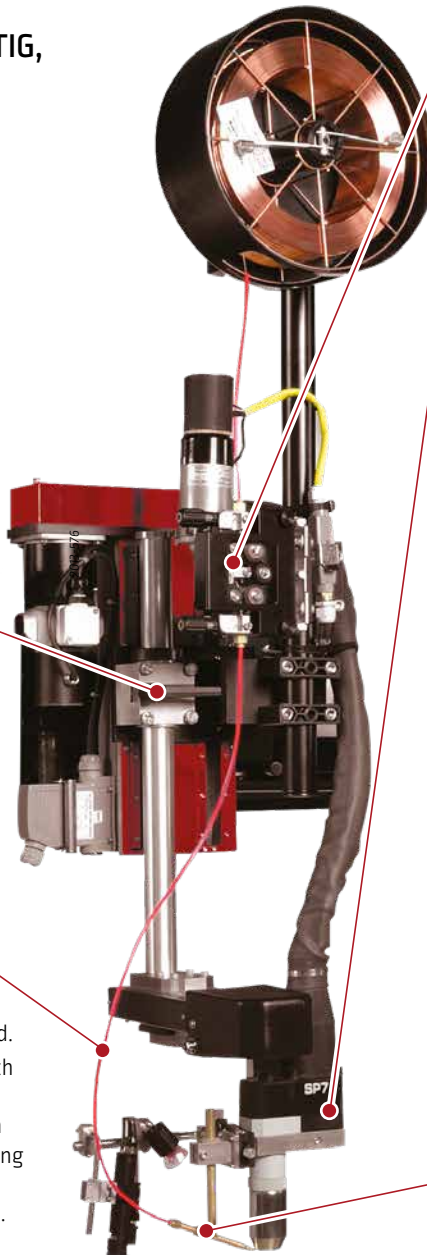

WIRE FEED

It is often necessary to feed the melting bath with metal during the operation in order to prevent the seam from showing hollows, to supply soft steels with deoxidizing elements, for successive seams.

TORCHES

Water cooled torches high performance to ensure quality and stability of the process and its equipments. Torches equipped with quick connection system for easy change and maintenance.

SP7:

- This torch is the reference in the market, for soft and key hole plasma welding.
- 450 A at 100%
- Standard electrode simple to replace and self-aligning
- Cold massive nozzle ensuring long life time



MEC4:

- For TIG welding
- 500 A at 100%
- Standard electrode easy to replace
- Twin HF ignition for better arc striking



Options:

- Gas trailing shield to protect welds in sensitive metals

Options:

- Gas trailing shield to protect welds in sensitive metals
- Magnetic arc oscillation

OCILLARC PLUS For TIG process

Arc deviation

This technique is used to electrically deflect the TIG arc forward in the welding axis, increasing the speed by 30 to 50% for thicknesses of less than 2 mm.



Arc oscillation

Arc oscillation is used to deposit metal over areas up to 15 mm wide to fill bevels or reconstitute surface coating.

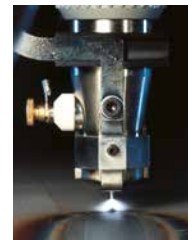

WIRE PLACEMENT

2 micro-slides allow a precise impact of the wire into the molten pool. Manual or electrical option.

CONTROL PANELS

Two different systems to manage the Plasma/TIG process are available.

According the typology of machine, the number of parameters to control, the monitoring and the traceability requirements.

	PILOT ADVANCE	
Typology of machine	<ul style="list-style-type: none"> Stand alone process for retrofit or integrators Simple machine with 1 analog axis 	<ul style="list-style-type: none"> Machine management including process with unlimited digital axis
HMI type	<ul style="list-style-type: none"> LCD display + quick access buttons 99 programs 	<ul style="list-style-type: none"> 19" user friendly touch screen Unlimited programs
User management	<ul style="list-style-type: none"> General lock 	<ul style="list-style-type: none"> User profiles management
Traceability & reports	<ul style="list-style-type: none"> Program import/export with Linc-Master program editor 	<ul style="list-style-type: none"> Program edition & WPS Production monitoring Welding ticket Process control Pilot cockpit OPC UA

PILOT ADVANCE WELDING ACTIVITY UNDER CONTROL

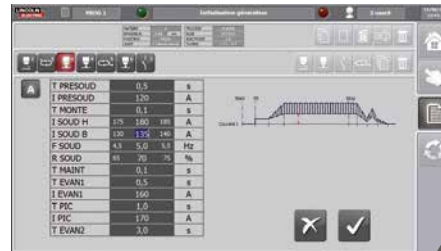

Clear display of welding cycle and related parameters

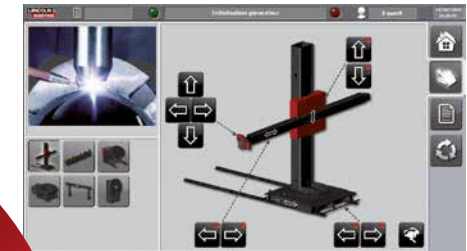

Graphic display of the machine and welding head



A suite of welding traceability and supervision embedded or off-line with Pilot Cockpit software



Quick access and display of welding functions



PILOT COCKPIT EXPLORE YOUR WELDING DATA

EDITION

- Export Programs into Excel format
- Export WPS into Excel format

TRACEABILITY

- Quick summary report after each bead

SUPERVISION

- Track all events of your daily job
- Alarms extract for maintenance analysis

OPC UA

INDUSTRY 4.0

Secure gateway to ERP system, real-time supervision

TOPTIG

Applications

TOPTIG process is a major innovation in the world of automatic welding. Developed in the Lincoln Electric research center, TOPTIG is a process that can be used effectively on carbon or stainless steel plates up to 3 mm or on galvanized sheets with weld brazing.

The activities sectors are:

- Automotive subcontracting
- Metal furniture
- Fine boiler making
- Aeronautics subcontracting



TOPTIG Process Principle

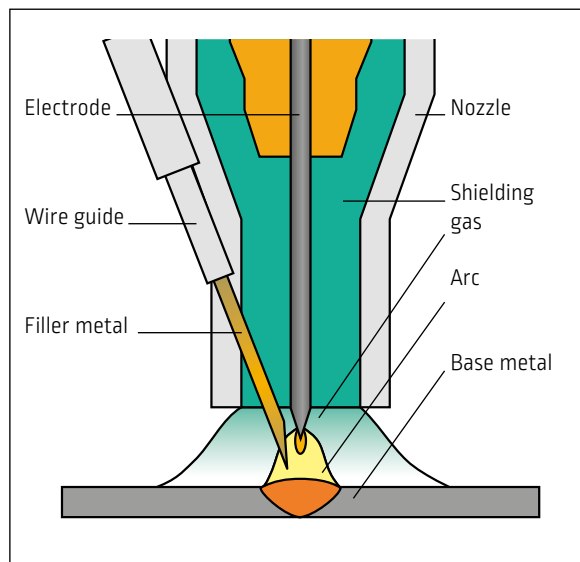

Torch accessibility

Compared with a traditional automatic TIG torch, the compactness of the wire lead-in incorporated into the nozzle gives accessibility at an angle comparable with that obtained using a MIG/MAG torch.

This increases the scope for robotization and extends the range of workpieces which can be welded automatically.



PLASMA / TIG MACHINES



The Plasma/TIG applications are multiple and varied, here some examples of machines which answer to the main customer needs.

Assembly of flat sheet metal and closure of vessel sections

Seamer bench for longitudinal welding.

The vessel is welded by plasma/TIG or plasma + TIG process inside the INTER seamer bench. The operator can see the joint and adjust the position of the torch thanks to a video camera device.

In/Out feed tables for material handling to help with production.

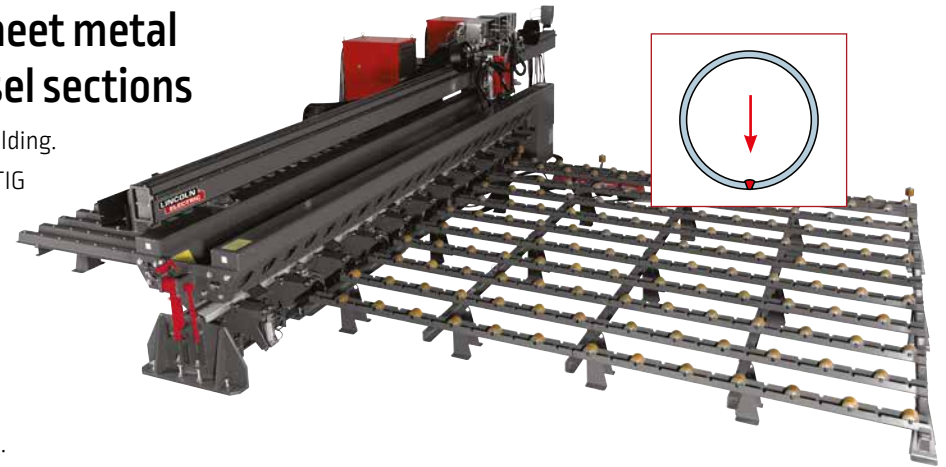

Assembly of vessels by conventional technique

Column and boom with rotators for circumferential welding.

To assemble 2 vessels, it's possible to put them on rotators and the plasma column and boom carries out the circumferential welding.

Safety and operator comfort are guaranteed thanks to the control of the welding operation from the ground.

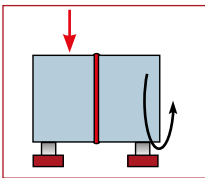

Assembly of vessel in vertical position

This technique is used mainly for large diameter vessels or products whose rigidity is low [ratio diameter, thickness, dimension].

The vertical assembly facilitates the handling of workpieces and reduce tooling needed.

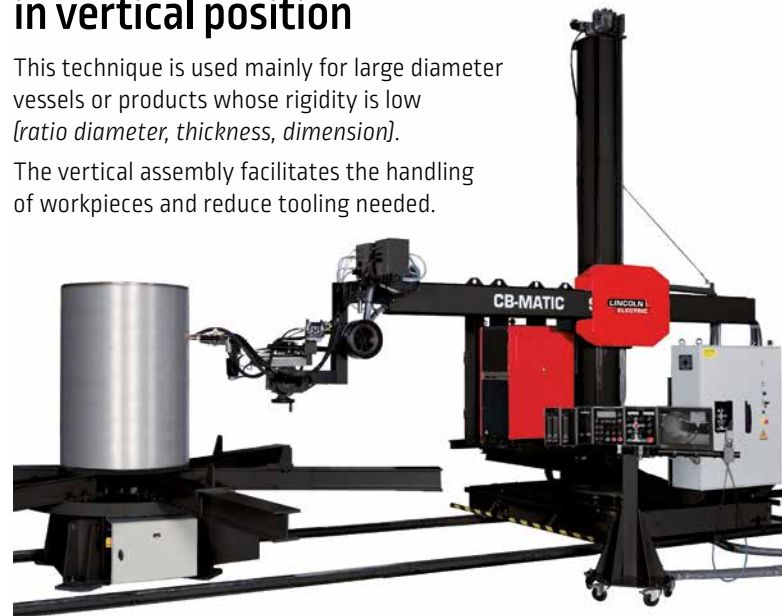

Column and boom with turntable for longitudinal and circumferential welding:

- Longitudinal in vertical down position
- Circumferential in cornice position

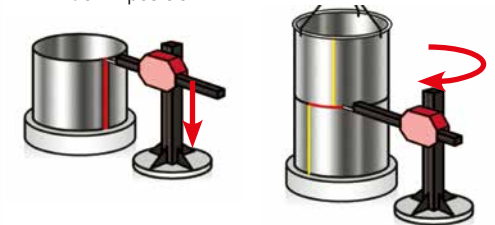

PLASMA / TIG MACHINES

Elliptical tank

The plasma torch movement is controlled by the column and boom.

The Headstock HLM+F allows the rotation of the tank and ensures a high flexibility for the mounting and the holding of the piece.



Pipe prefabrication assembly



Mechanisation machine with plasma process and Pilot Advance control to weld pipes with elbows and flanges.

The work piece is positioned on the X-rotators and the motorised headstock carries out the rotation.



Pipe production fully automated process

Complete welding system with:

- Column and boom equipped with plasma + TIG process for external longitudinal and circular welding
- Fixed internal boom equipped with TIG head for internal remelting
- Pipe holding device with rotators on carriages to turn and move the pipe

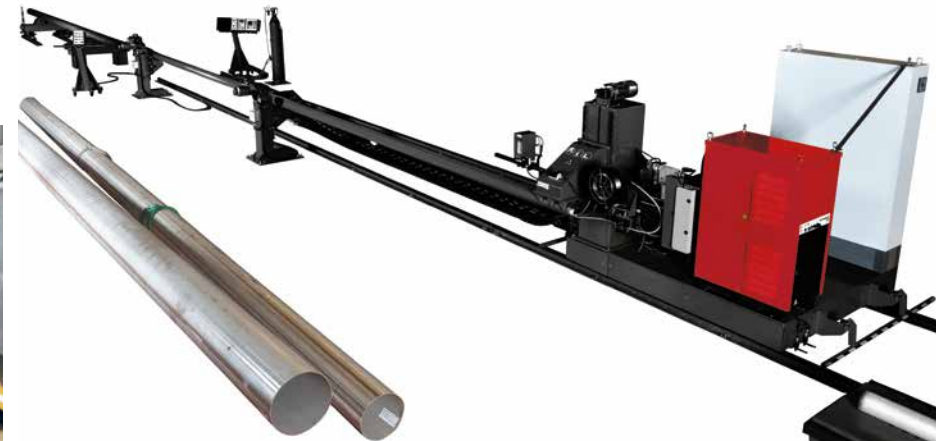

SAW SUBMERGED ARC WELDING

Applications

Process for welding and hard surfacing of low alloyed carbon steel, stainless steel and refractory steel. It combines productivity, quality and operator comfort.

It is used in thicknesses from 3 to 300 mm and provides a high welding speed and high deposition rates. With one or more wires, it is found in many industries: infrastructure, shipbuilding, offshore pipe mill, heavy duty pressure vessels, energy...

Performances

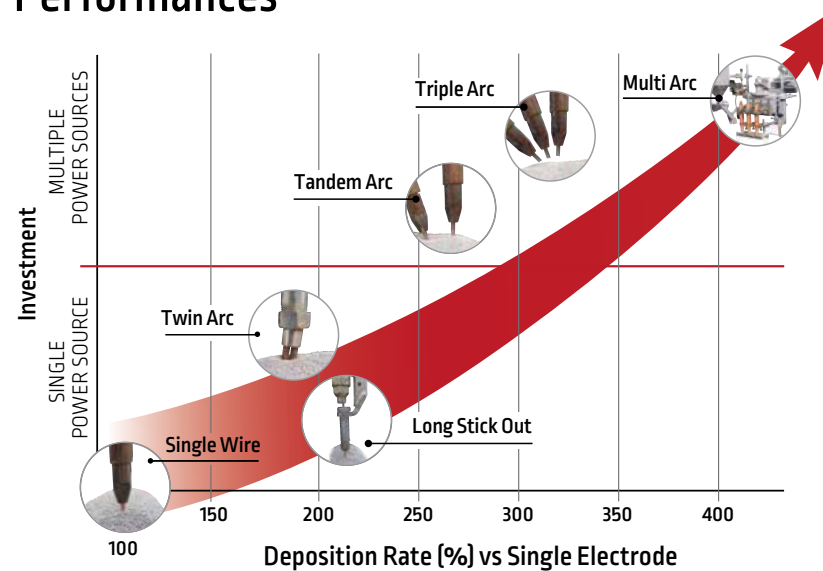

LSO: Long Stick Out

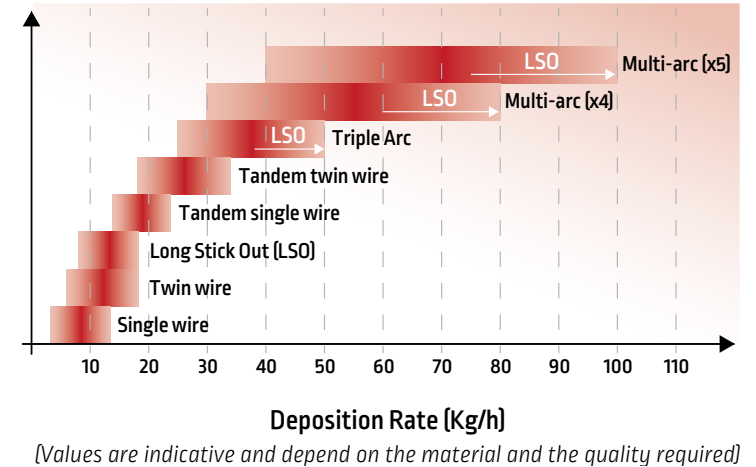

AC wave form

Complete management of the AC wave form with the control of the frequency, balance and offset for a maximum flexibility of production.

Control the penetration and geometry of the weld bead.

Eliminate the effect of magnetic arc blow.

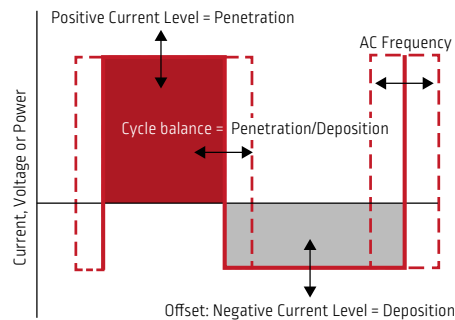
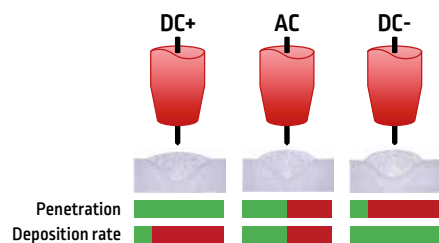

With AC wave form, increase deposition rate up to 50%.

LSO: Long Stick Out

In submerged arc welding, Stick Out, is the distance between the contact tip and the work piece. This distance can be increased using dedicated extensions to obtain what is known as Long Stick Out (LSO).

The wire electrical resistance increases with its length. Thanks to the "Joules" effect, the electrode is pre-heated and melts faster than it would, at the same amperage, with standard Stick Out.

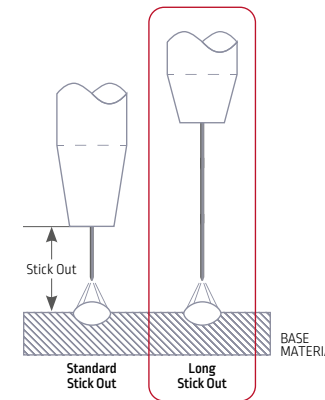

LSO combined to AC wave form, increase deposition rate up to 100%.

SAW INVERTER POWER SOURCE

POWER WAVE® AC/DC 1000 SD

Lincoln Electric offers inverter technology for DC and AC SAW with Power Wave® AC/DC 1000 SD:

- Efficient power consumption reducing operating costs
- High duty cycle at 100%
- Easy to integrate from conventional interface to digital unit
- Multi-purpose installation:
 - CV: Constant Voltage
 - CC: Constant Current
- True Energy™: measures, calculates and displays instantaneous energy
- Check Point™: a cloud-based system to view or analyse your welding data
- Control panels:
 - MAXsa® 10
 - PILOT PRO



THE LINCOLN ELECTRIC GREEN INITIATIVE

Inverter Technology
reduces energy demand

www.lincolnelectric.com/green



The **MAXsa® 19** controller is specifically designed to relay wire feed commands to the MAXsa® 29 when a customer-supplied user interface like Pilot Pro is used in place of the MAXsa® 10 controller.



The compact **MAXsa® 29** feed head is the latest solution for submerged arc applications. Powerful motor with 2 rollers and wire straightener included. Wire sizes from 1.6 to 5.6 mm. Rated output current 1000 A @ 100%.

POWER WAVE® AC/DC 1000 SD

Power supply	380-575 V / 3 ph / 50-60 Hz
Effective power at 100%	55 kVA
Current range	100-1000 A
Duty cycle at 100%	1000 A / 44 V
Weight	363 Kg
Dimensions L x l x H	1248x501x1184 mm
Protection index	IP 23

SAW INSTALLATION

A large range of welding heads

Tubular version for multipurpose applications:

- Flat welding
- Longitudinal or circular fillet
- Single
- Tandem
- Long Stick Out
- Narrow gap

Dedicated heads for internal diameters.

Remote control RC-MATIC

For immediate action throw push buttons. Connected at the welding head through a cable of 5 m, The operator can get the useful basic function of SAW head management. Fixation of the remote control is secured by a magnet.

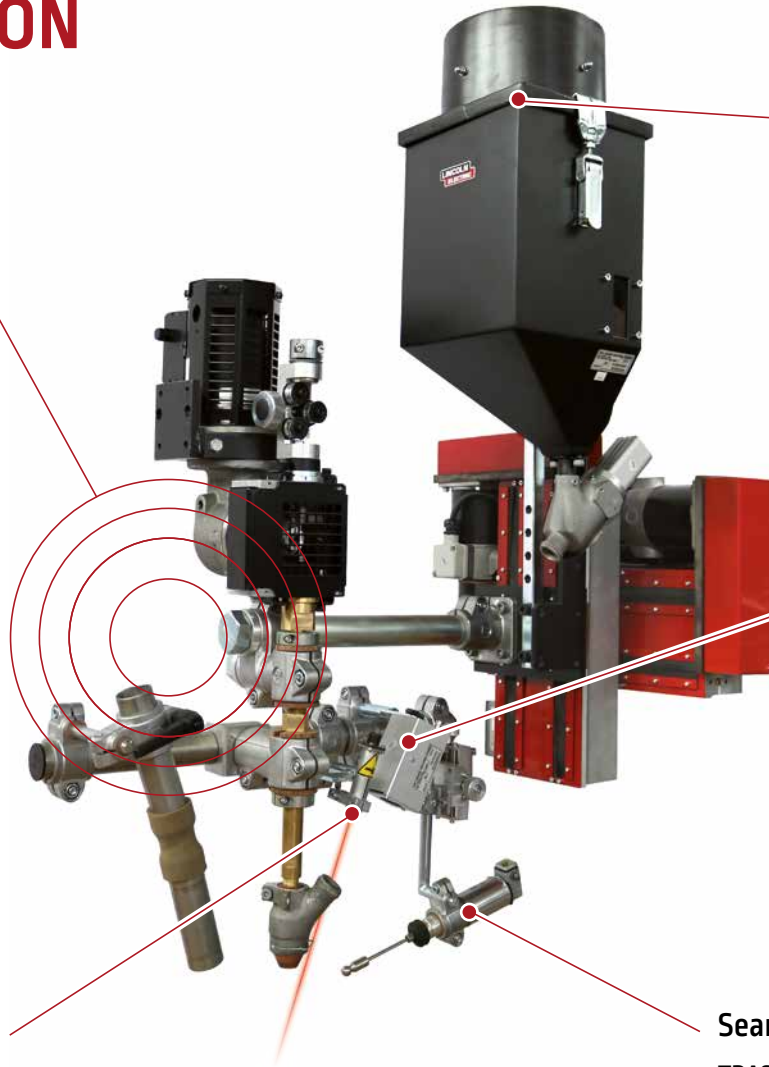

Flux recovery equipment

A compact unit to significantly reduce manual refilling and improve productivity.

- Hopper 10 liters
- Powered by compressed air
- Pressure 4 to 6 bars
- Venturi device with tank
- Filter cartridge for recovery and dust filtration

Centralised recovery

Centralised flux recovery system through pushed flux device and electrical turbine.

Ideal system for heavy duty applications.

- Filtration of flux dust
- Reduced flux consumption
- Minimum flux handling
- Optional device to keep temperature of flux up to 120 or 200 °C

Video Camera

Combined with a laser spot, the video camera unit allows to view the welding area and can remotely control the positioning of the torch in the joint. This is an essential tool for welding in difficult access area like inside a tank of small diameter. The equipment is supplied with a spot light to illuminate over viewed area, and a color LCD industrial screen high definition 15".



Laser spot

To show the wire point of impact relative to the joint on the workpiece. The spot projects an illuminated point in front of the electrode wire for guiding. One spot is used for horizontal alignment and the association of two spots make it possible to monitor the horizontal and vertical position.

Seam tracking

TRACKMATIC device guarantees the good positioning of the torch in the joints to be welded without operator intervention.

A sensing probe finger or an inductive or laser sensor allows joint tracking (*height or alignment*) and commands the necessary corrections required to the torch trajectory thanks to motorised slides travel 100-200-300 mm.

Whilst increasing productivity, it ensures a constant weld quality, a reduction in repair operation and easier use for the operator.

CONTROL PANELS

Two different systems to manage the SAW process are available.

According to the typology of machine, the number of parameters to control, the monitoring and the traceability requirements.

	MAXsa®10	PILOT PRO Plus
Controls	<ul style="list-style-type: none"> Submerged Arc Process management only 1 Power Wave® AC/DC 1000 SD 	<ul style="list-style-type: none"> Submerged Arc Process management and machine, including axis motion, head accessories, slides and tracking Up to 3 Power Wave® AC/DC 1000 SD
HMI	<ul style="list-style-type: none"> LCD display + quick access buttons Mobile pendant 8 programs 	<ul style="list-style-type: none"> 12" user friendly color touch screen + quick access buttons 500 programs Integrated Advance multi-pass and process change on the fly
User management	<ul style="list-style-type: none"> Programs lock 	<ul style="list-style-type: none"> User profiles management Parameters supervision: Process control
Traceability & reports	<ul style="list-style-type: none"> CheckPoint 	<ul style="list-style-type: none"> Pilot cockpit, integrating program edition, production monitoring and welding ticket Industry 4.0 and remotely service compatible OPC UA

PILOT PRO *Plus*



Clear display of welding parameters



A suite of welding traceability and supervision embedded or off-line with Pilot Cockpit software

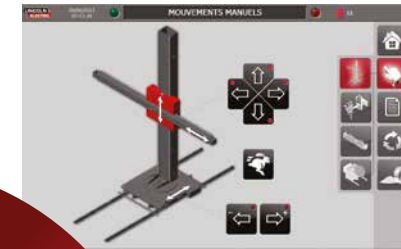

Graphic display and control of the machine and welding



PILOT COCKPIT EXPLORE YOUR WELDING DATA

<p>EDITION</p> <ul style="list-style-type: none"> Export Programs into Excel format Export WPS into Excel format 	<p>TRACEABILITY</p> <ul style="list-style-type: none"> Quick summary report after each bead 	<p>SUPERVISION</p> <ul style="list-style-type: none"> Track all events of your daily job Alarms extract for maintenance analysis 	<p>OPC UA</p> <p>INDUSTRY 4.0</p> <p>Secure gateway to ERP system, real-time supervision</p>
---	---	---	--

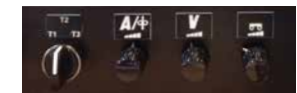

Quick access and display of welding functions adjustable during cycle by direct buttons

SAW HEADS & CUSTOM APPLICATIONS

Lincoln electric offers a large range of welding heads from standard to special models for a perfect adaptation to the customer application.

Standard heads

- From single up to triple arc
- Internal diameter 1500 mm.

Single Arc



Tandem Arc



Triple Arc



Compact heads

- From single to tandem arc

Internal diameter 750 mm



Internal diameter 500 mm



Tandem Long Stick Out head

Mainly used to increase deposition rate, then the travel speed will increase as well with benefit of better productivity, number of passes reduced, and cost reduction.

It can be used in single wire, or multi wires with a choice of 1 or 3 LSO torches, in all these industrial applications:

- Power Generation
- Nuclear
- Pressure Tanks
- Windmill
- Petrochemical
- Infrastructure

LSO combined to AC wave form increase deposition rate up to 100%.

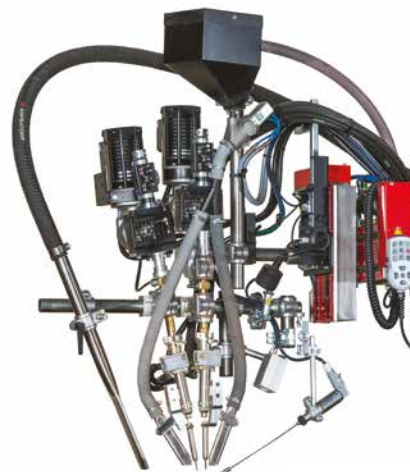

Narrow gap head

Narrow Gap process used for welding thick plates. Mainly for the following industrial applications:

- Power Generation
- Nuclear
- Pressure Tanks
- Windmill
- Petrochemical

Process

It is a Submerged Arc process with single or tandem narrow gap torch, designed to weld thick plate (generally over 50 mm) using practically parallel sides and narrow gap preparation. Narrow gap process allow to increase productivity and to result in lower cost welding by decreasing the volume of metal needed and the welding time compared to conventional preparation with bevel. The process is adapted for both longitudinal and circumferential welding.



SAW EQUIPMENT

Flux management

Equipment to improve productivity and ensure operator safety.

Flux recovery

A compact unit to significantly reduce manual refilling of the flux feed hopper 10 liters. Powered by compressed air. Pressure 4 to 6 bar. Venturi device completed with tank and filter cartridge for recovery and dust filtration.

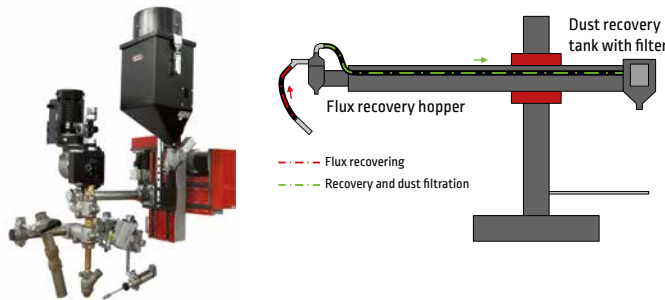

Pushed flux

Pushed flux supply system providing a greater welding autonomy due to the flux tank capacity of 70l.

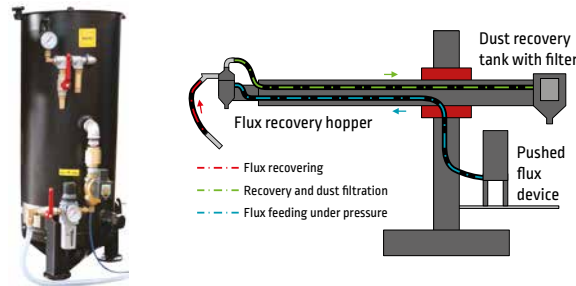

Centralised recovery

Centralised flux recovery system through pushed flux device and electrical turbine with filtration of flux dust. Ideal system for heavy duty application with reduced flux consumption and minimum flux handling. The system can be equipped with a device to keep the temperature of the flux up to 120 or 200 °C.

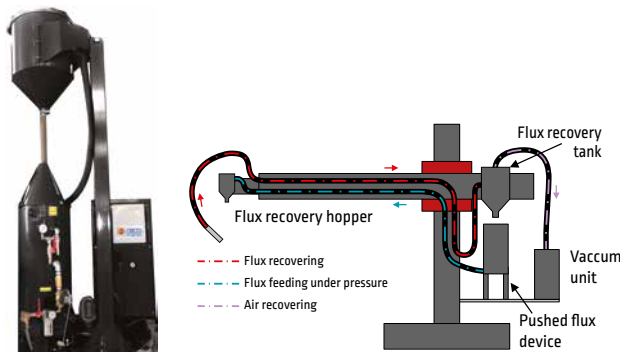

Wire management

Lincoln electric proposes optimized packaging solutions for submerged arc welding. All wires are free from any organic component limiting the diffusible hydrogen contribution to the weld metal.



Drum accessories:

Turn table

designed to dispense all sizes and grades of wire. 4-axis adjustable arm with ceramic inlet guide prevents wire shaving. Quick disconnect allows for easy conduit connections.



The pneumatic Feed Assist

provides an economical method to assist your wire feeder in moving wire through the conduit in applications where long conduit runs are necessary.



Butt welder

This device makes it possible by butt welding the end of a drum [or a reel] with the beginning of the next one. It reduces machine downtime, as there is no longer need to pass the welding wire through the conduit.



SAW TRACTORS

SAW tractors to perform regular welds for many applications:

- Bridge and barge decking
- Offshore
- Heavy manufacturing
- Shipbuilding
- Large tank fabrication
- Beam fabrication

LT-7 tractor

A self-propelled mechanized wire feeder, designed for submerged arc welding with track system capabilities.

- It is self-guiding and easy to operate straight or curved welds
- Wire size 2.4 to 4.8 mm travel speed 0.12 to 1.8 m/min
- Recommended with **IDEALARC®** power sources



CRUISER® tractor

For single or twin wire, the self-propelled modular travel carriages can deliver deposition rates up to 13kg per hour for butt and fillet joints on lengthy plate welding applications.

- Advance control pendant with digital meters
- Wire size 1.6 to 5.6 mm
- Travel speed 0.25 to 2.5 m/min
- Recommended with **POWER WAVE® AC/DC 1000 SD** power source



MEGATRAC TANDEM tractor

The best solution for the harshest environments and applications. This very robust and stable carriage is specially designed for tandem welding with the Long Stick Out process.

- 2 flux supply systems, 2 wire spools
- LED lighting
- 4 slides to adjust head position
- Optional transportation platform
- Delivered with **POWER WAVE® AC/DC 1000 SD** power source

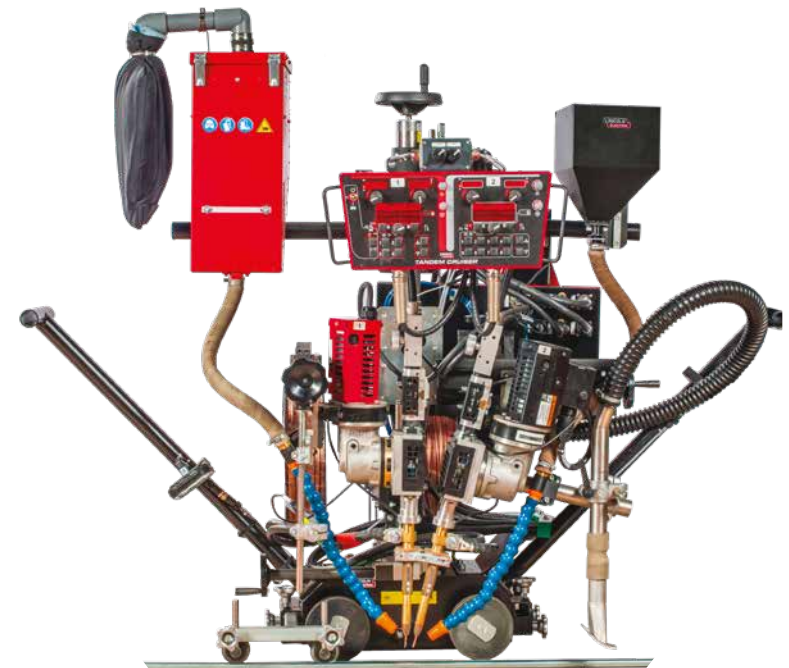

SAW MULTIPLE WIRES

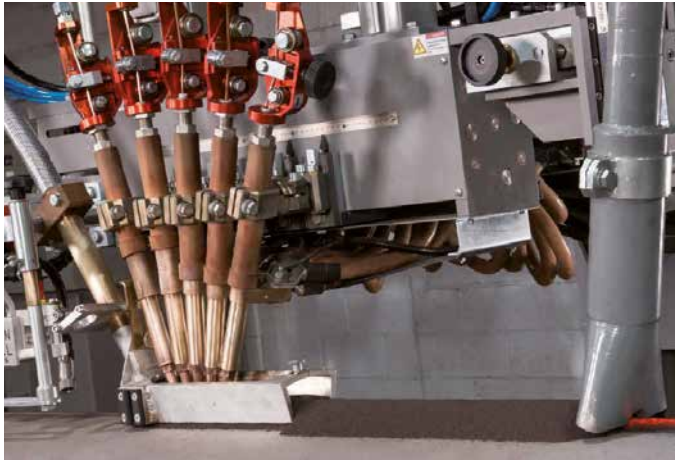

3arc welding head

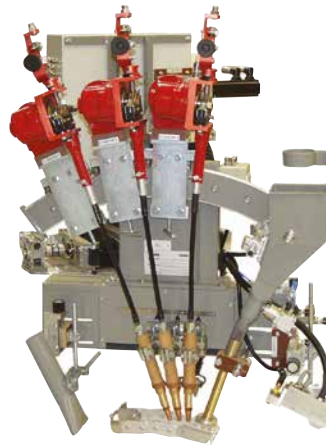

Helical or circumferential welding



Longitudinal welding

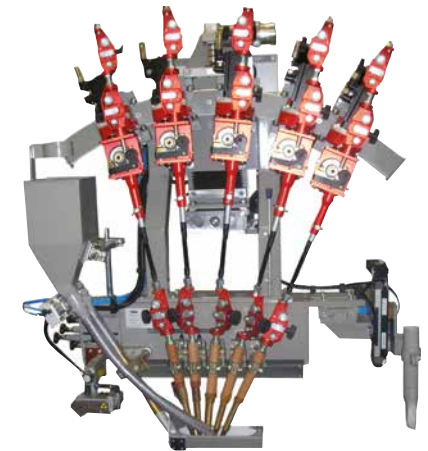

PERFORMANCES

SAW MULTI-ARCS SYSTEM

The **Lincoln Electric** Automation proposes to integrate multiple wires head from Uhrhan & Schwill company world-renowned specialist for Pipe Mills segment.

E5 system

The E5 system manages all the parameters of the multi-arcs welding and it can be associated to another controller for a complete management of the machine:

- Single arc, Tandem arc or triple arc
- Long Stick Out process
- Touchscreen based remote control
- Management of programs and memorization
- Manual control of wire and flux feeding
- Display of all real-time measurement values like voltage, amperage, wire feed speed, torque



Z5 system

The Z5 system manages the complete machine components and all the parameters of the multi-arcs welding:

- From single arc to multiple arc (x6)
- Long stick out process
- Large touchscreen
- Full control of wire and flux feeding system
- Display and recording of all real-time measurement values like voltage, amperage, wire feed speed, torque, movement speed...
- Seam tracking by laser scanner

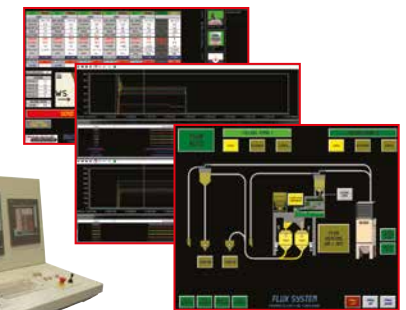

STRIP CLADDING PROCESSES



Cladding is a fundamental process in the pressure vessel industry and is applied across whole spectrum of applications, from Nuclear, Oil and Gas industries to Chemical Processing equipment and steelmaking.

Cladding is required on the process side of high pressure critical process plant equipment to provide corrosion resistance against highly severe corrosive service fluid or to increase wear resistance of a component being subjected to heavy wear and tear applications e.g. continuous casting rollers in steel mills.

Submerged arc strip cladding

- The arc causes more penetration into the base material, resulting in dilution levels of ~20%
- Deposition rate: 12-14 kg/h for 60 x 0.5 mm strip
- Current range restricted to limit dilution

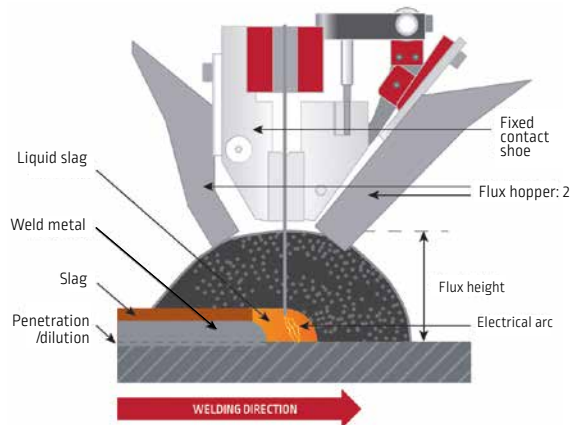

Electro slag strip cladding

Conventional

- Arc-less process, use conductive flux and works on Joule's resistance heating principle
- The strip current passes through the molten slag. The resulting resistance heating effect melts the strip and deposits the molten weld pool onto the base material
- Low dilution level (9 to 12%). Process has significant advantages over SAW

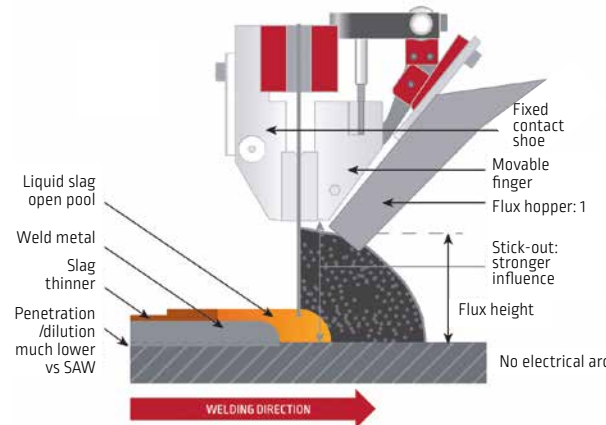

Hybrid Technique*

- Hot metal cored wires added to the molten pool as 3rd constituent
- Always in single layer, coupled with high welding speed
- Lowest dilution level coupled with the highest deposition and faster surface coverage rates

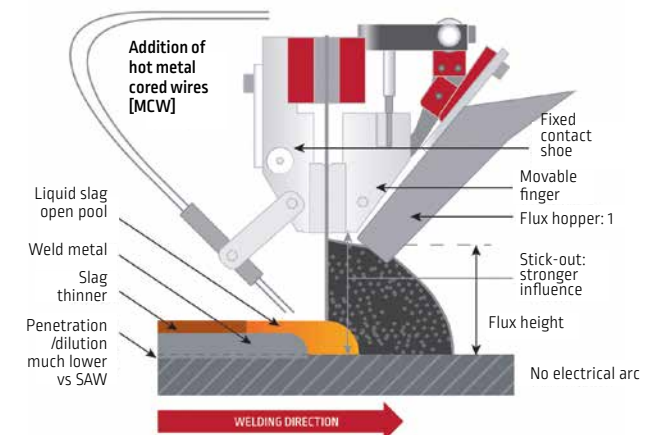

STRIP CLADDING PROCESSES



Welding heads

- In-house designed heads for strip widths 15 to 120 mm
- Water cooled and robust modular design
- Power cables can be added as required
- Easily oriented for desired welding direction

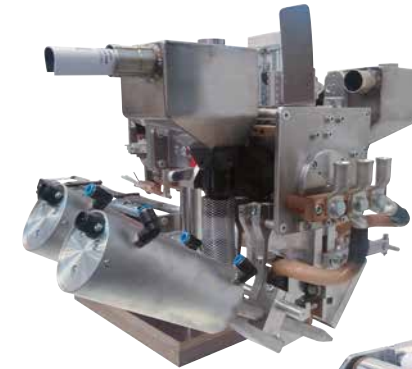

Standard head



Internal head

Comparison:

- Submerged arc (SAW)
- Electro slag conventional (ESW 2D)
- Electro slag hybrid* (ESW 3D)

	Submerged Arc	Electro slag	
		Conventional	Hybrid*
Consumables	Strip + SAW Flux	Strip + ESW Flux	Strip + Metal Cored Wire + ESW Flux
Deposition rate [Kg/h] 60 x 0.5 mm strip	12-14	22-30	28-42
Welding speed [cm/min]	10-14	Normal speed: 15-18 High speed: 24-35	24-40
Minimum number of layer in Ni-625 to achieve <5% Fe chemistry	2	2	1
Flux type for high speed cladding in single layer	NA	Alloyed	Neutral

* Patent Pending

E5 controller

- Management of the welding process with the E5 system and its mobile console.



SAW COLUMN & BOOM

C&B allows an easy and robust positioning of the submerged arc welding process. Ideal for many industrial segments such as:

- Pressure vessel manufacturers
- Heavy fabrication in mild steel or stainless steel
- Chemical processing
- Power generation, energy
- Infrastructure

Available in various sizes and load capacity, in fixed or mobile version, with a large choice of options C&B is the best versatile equipment of workshops.

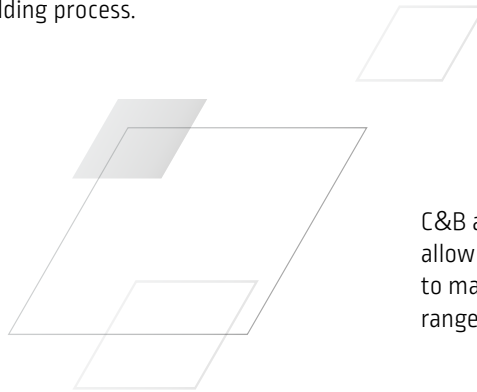

C&B associated with various positioning systems allow the movement or rotation of the parts to maximize the use of the equipment in a large range of applications.

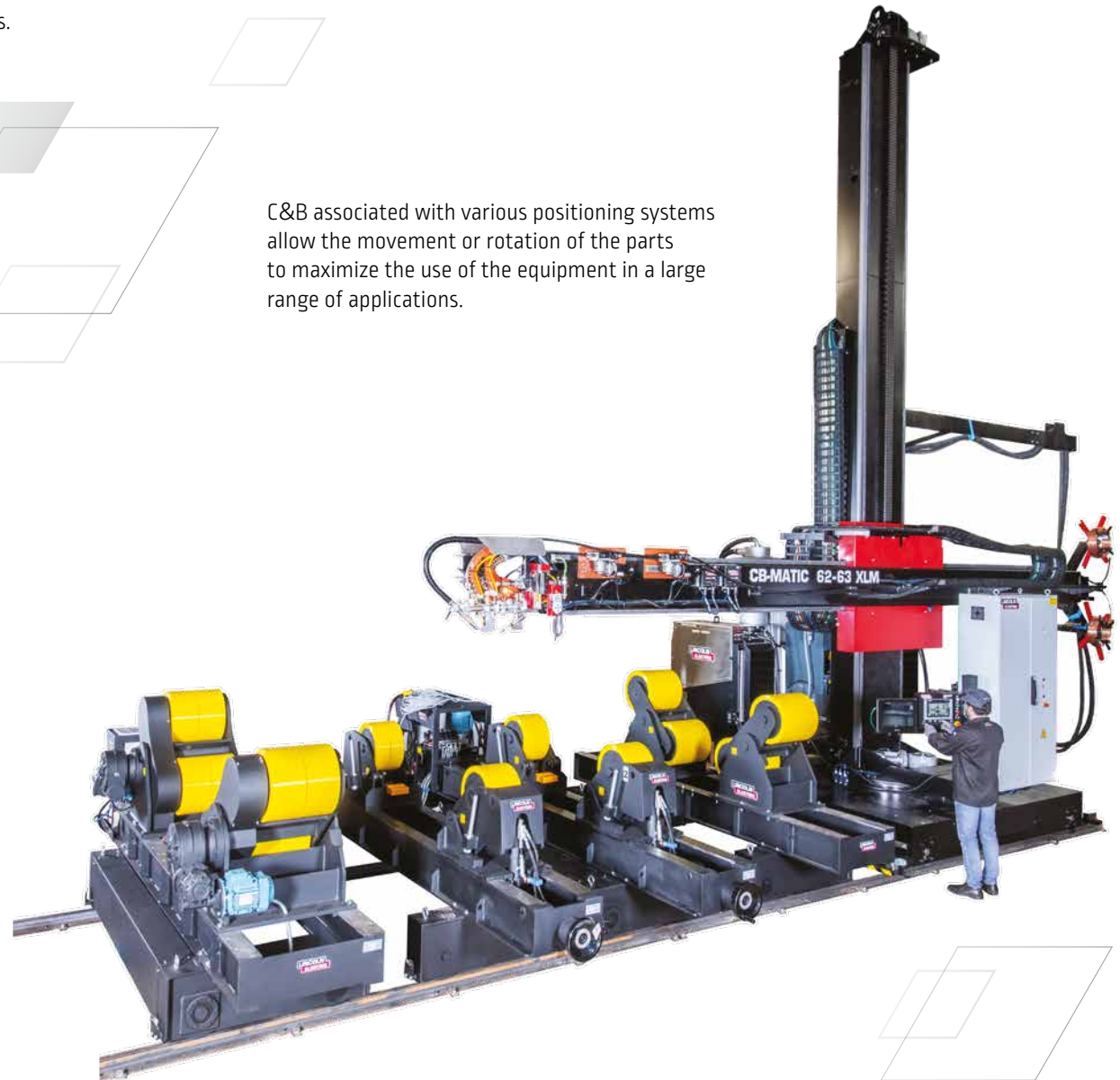
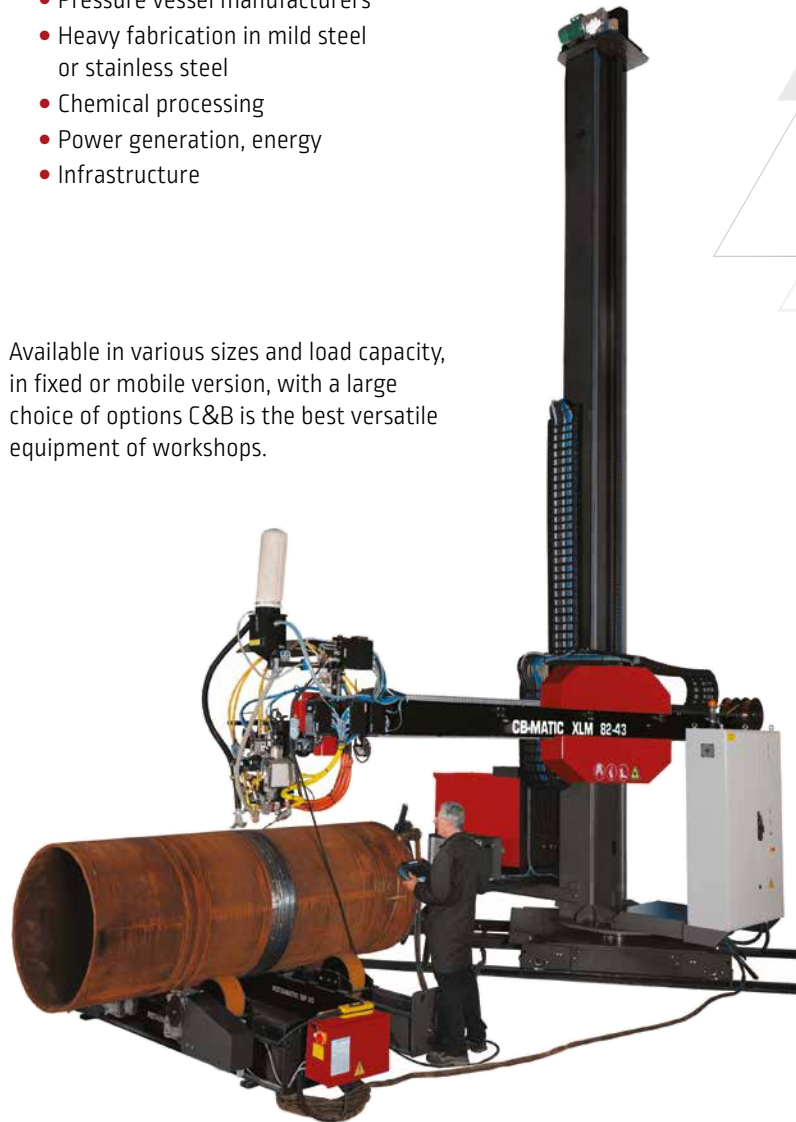

SAW INTERNAL BOOM



The main processes are:

- Pipe manufacturing by internal longitudinal welding
- Assembling of 2 pipes by circular welding

Once the internal weld is done, the outside weld is performed by another equipment. The structure and configuration of the internal boom depends of the length of the pipes. Pipes from 4 m to 12 m long.



BEAM-MATIC

The automation of long workpieces welding (*beams, wagons, box section constructions*) requires sophisticated machines which move on rails.

The **BEAM-MATIC** system is used to weld beams of constant or varying cross-section in widths between 220 and 2000 mm*.

* Other dimensions on request.

2 types of **BEAM-MATIC** are available:

- Cantilever: CT
- On base column and boom: LM

The **BEAM-MATIC** allows to weld in MIG-MAG or SAW (*single or twin wire*) process. In standard, the machine is equipped with a flux recovery device and a pushed flux supply.

Possibility to use wire spools or wire drums on the 2 **BEAM-MATIC**.

The torch level is fix on the **BEAM-MATIC CT** and it's possible to lift the torch level on the **BEAM-MATIC LM**.



BEAM-MATIC CT

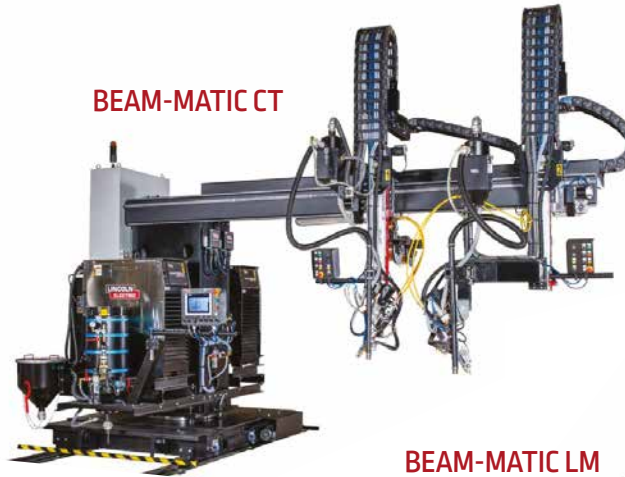

BEAM-MATIC LM

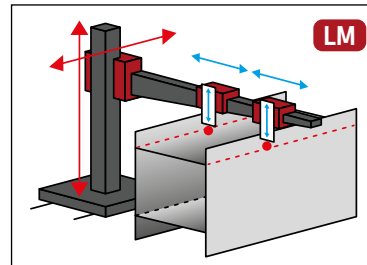
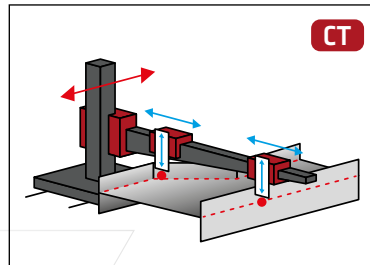
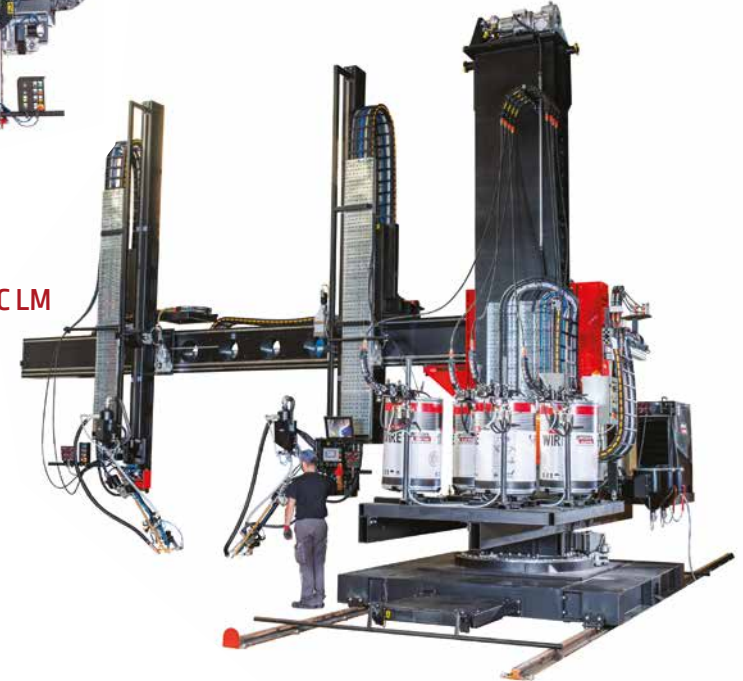

Clamping bench:

The clamping bench allows the positioning of the web and the flanges before the welding, with an additional clamping bench it's possible to save time and increase productivity.



Standard / Dimensions for clamping bench

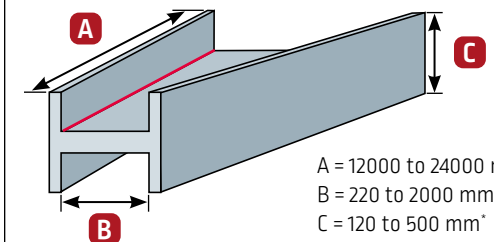

Web thickness: 4 to 20 mm
 Flange thickness: 10 to 30 mm

* Other dimensions on request.

LAMP-POST SOLUTIONS

High productivity performance machine equipped with SAW or Plasma welding process. No tacking of parts is required.

A dedicated software manages the lamp post production including automatic positioning of the pole edges before welding according to the various shapes and conicity of each product.

A burner ramp or an inductive system under the lamp-post reduces the welding distortions.

Several options are available on request.

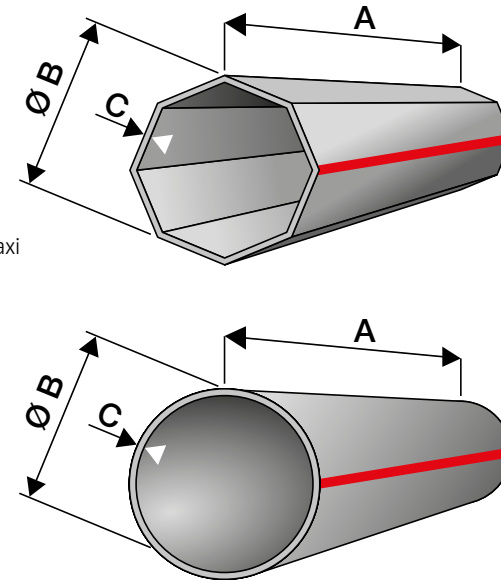
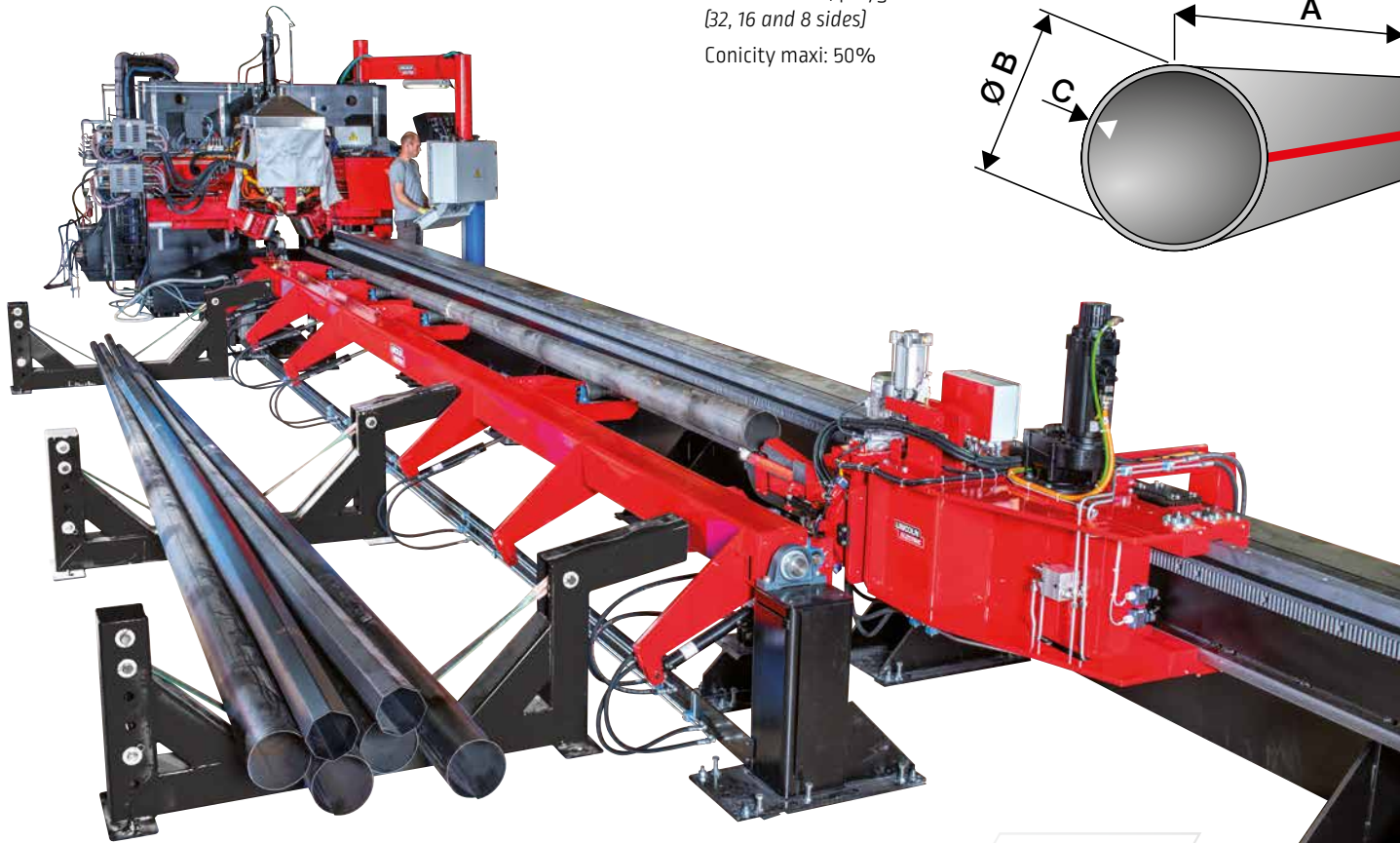

A: 3 to 17 m
B: 60 mm mini - 600 mm maxi
C: 3 to 6 mm
 Round conical, polygonal
 [32, 16 and 8 sides]
 Conicity maxi: 50%



WELDING PROCESSES

- SAW single wire diameter from 1.6 to 5.0 mm
- Plasma welding 3 or 4 heads

MACHINE CYCLE

- PILOT controller
- Overview and control in real time of the machine, parameters recording, remote connection

PERFORMANCES / OUTSTANDING POINTS

- Joint tracking with camera and operator joystick
- Joint tracking with laser vision
- Only 1 operator
- Machine availability: 95%
- Fix machine / Movable piece
- Speed range: 1 to 6 m/min*

* depending on penetration request

GANTRY SOLUTIONS

Gantry moving on rails with two torches SAW Single/Tandem or MIG/MAG process to answer applications requiring a high level of productivity for the manufacture of large parts such as beams, wagons, box section construction.

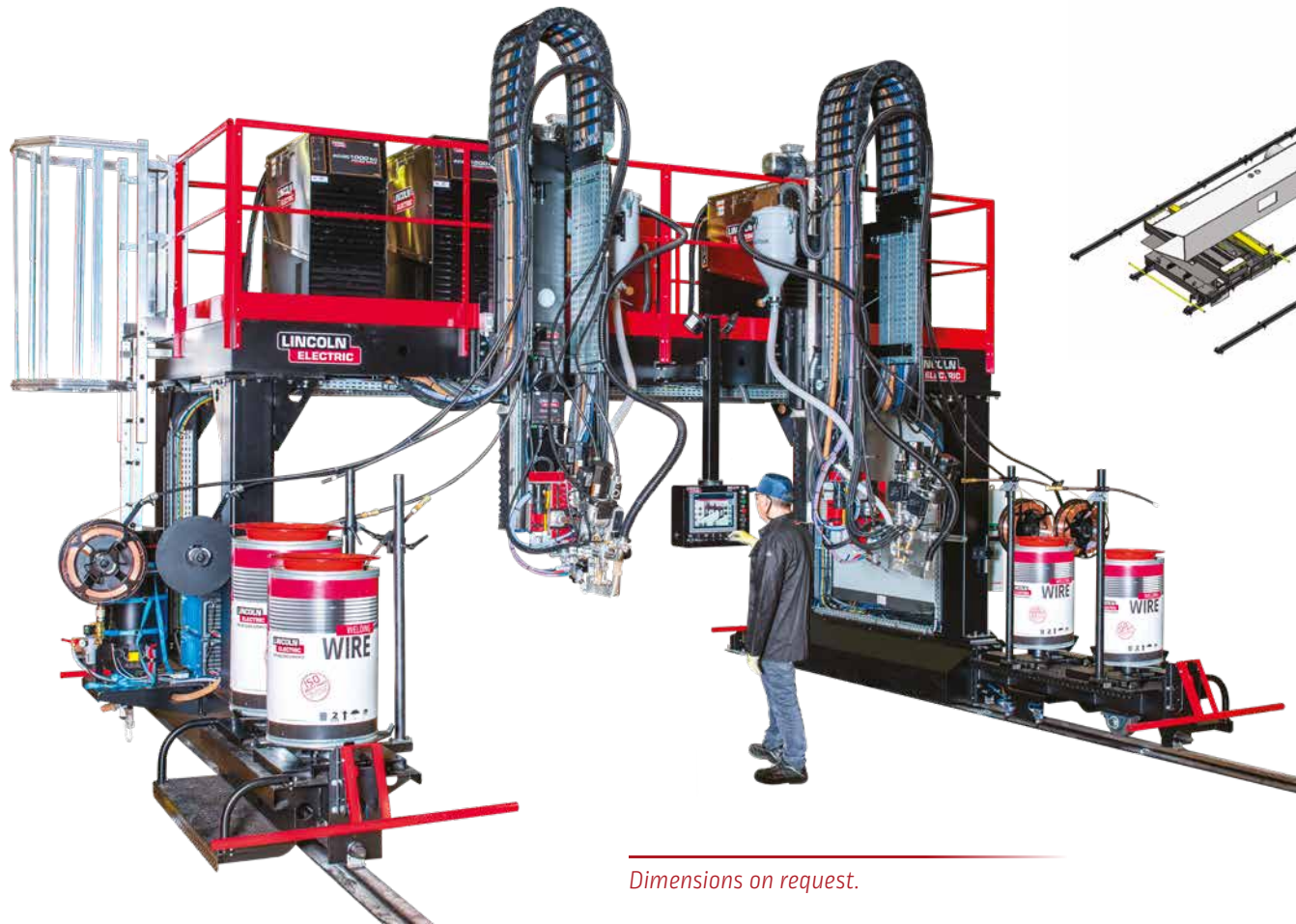

Dimensions on request.

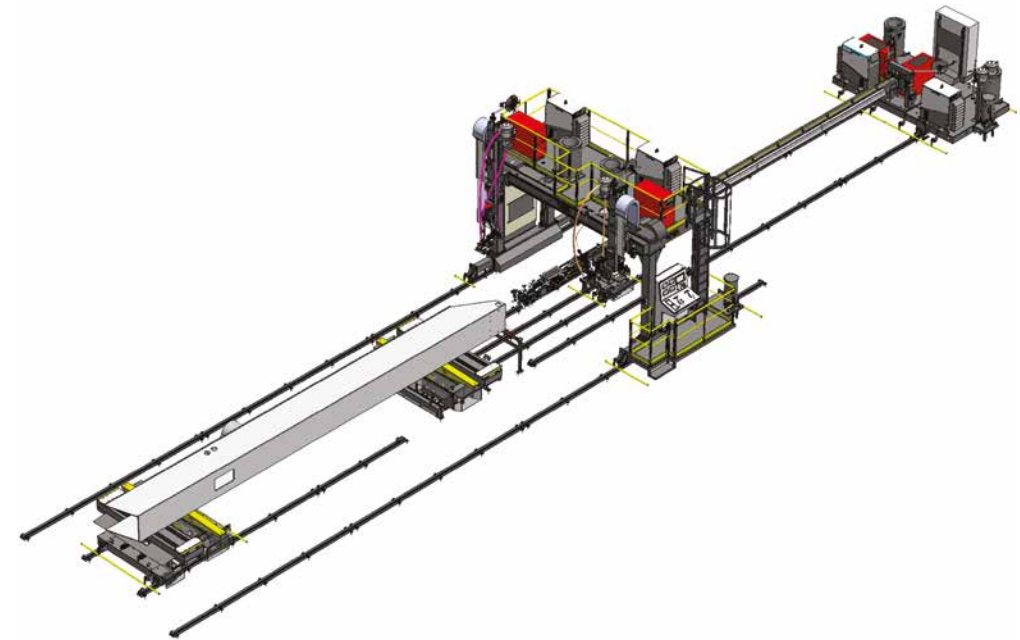

PILOT PRO *Plus*

for a complete management of the machine :
processes, movements and peripherals



MIG/MAG WELDING EQUIPEMENT

Multi-processes power source

The multi-process **Power Wave® R450** integrates Lincoln Electric performance technology for welding on thicker materials.

It provides an extremely fast arc response for optimized performance on almost any application and efficiently converts input power to reduce operational costs.



POWER WAVE® R450

Duty cycle at 100% (at 40°C)	450 A / 36.5 V
Primary power supply	230/400/460 V - 3 ph - 50/60 Hz
Max primary consumption	54/30/27 A
Current range	5 to 550 A
Weight	68 kg
Dimensions (W x L x H)	355x630x571 mm

PILOT PRO Digital management

The PLC controller **PILOT PRO** with Arlink® XT protocol for a complete management of all the machine movements and the MIG/MAG process inside.

- **9" color touch screen**
- Control process
- User profile
- Multi language
- **500 programs memory**
- Data exchange vis USB stick
- **Ethernet connection**



Add-on modules for Power Wave® R450

STT® Module

- Ideal for productivity and quality improvements with STT® welding and Rapid X®



Advanced Module

- Further expands welding capabilities adding AC polarity, also included STT® welding and Rapid X®



AutoDrive® 4R220

- Powerful and dependable robotic wire feeders
- Patented MAXTRAC® 4-roll drive system
- Best in class torque for high-speed applications
- Precise speed control



MIG/MAG & HYPERFILL® INSTALLATION

The **HyperFill®** twin-wire MIG solution was developed to revolutionize heavy fabrication productivity. Designed for semi-automatic and robotic applications, HyperFill® redefines high deposition welding - allowing you to make larger welds, faster and more easily.

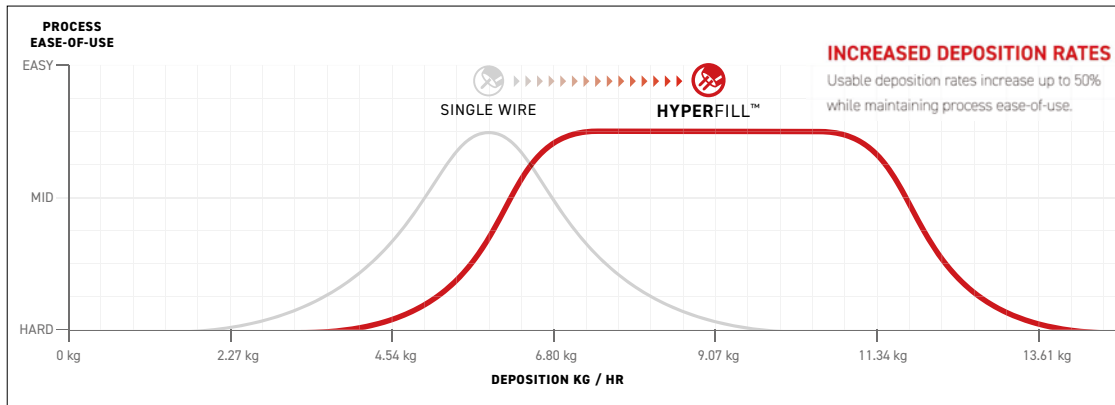

Wire feeder

AutoDrive® 4R220.
Powerful and robust wire feeders with 4-roll drive system.

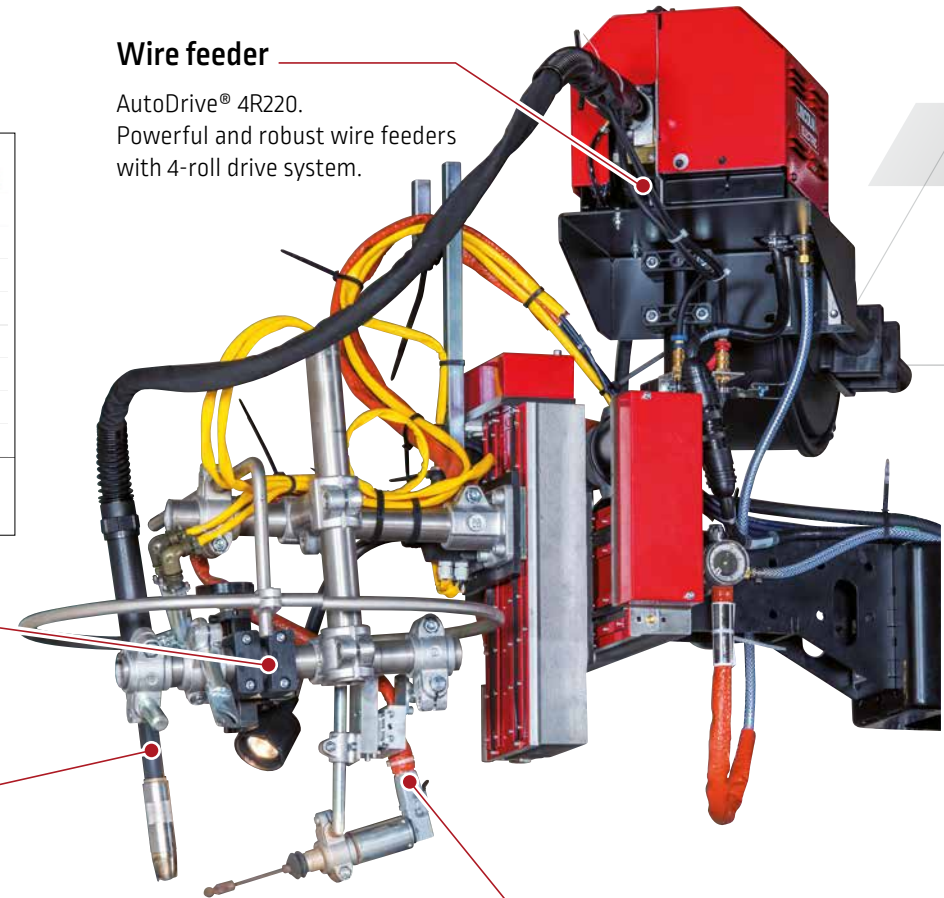

Video camera

The video system including protection against spatters and fumes, can be easily integrated. It uses a greatly enlarged image to be viewed thus making the operator's work easier and improving the quality of the welding operation.

Torches

Water cooled torches dedicated for automatic welding MIG/MAG installations.

- Excellent cooling up to the nozzle holder
- Good gas protection with the long shape of the nozzle

Seam tracking

TRACKMATIC device guarantees the good positioning of the torch in the joint to be welded without operator intervention. It ensures a constant weld quality, an increase of productivity.

Characteristics	TM 501W	TR 600	TM 700	Magnum Pro
Duty cycle	500 A at 100%	400 A at 100%	700 A at 100%	550 A at 100 %
Wire diameter (mm)	1 to 2.4	0.8 to 1.6	1.2 to 3.2	2 x 1.2
Harness length (m)	1 to 2.5	1 to 4	Without - direct connection	1.3 to 3.5
Version	Straight or curved 22 or 45°	Straight or curved 22 or 45°	Straight	Straight or curved 22 or 45°
Option	-	500 A at 100% with cooled nozzle	Additional gas protection for light metal alloy	-

MIG/MAG CARRIAGES

Carriages for MIG/MAG welding



Thanks to a modular design, the carriages can be used in different configurations.



WELDYPocket



WELDYPCar



WELDYPStiffener



WELDYP-Rail 2.0 Pro

Autonomous carriage with rechargeable battery. MIG/MAG welding with manual equipment.

Flat position welding, small footprint. Basic application, easy implementation.

All positions welding (*permanent magnet*). Start with welding arc detection. Exists in 2 models:

- WELDYPCar,
- WELDYPCar PRO with programming (*continuous welding or not*).

Welding with 2 manual welding torches. Programmable carriage. Exists in 2 models:

- for height: 60-160 mm,
- for height: 120-320 mm.

All positions welding of carbon steels, Stainless steels and aluminium. Start with welding arc detection.

- Programming welding distance,
- Welding start connection.

Applications

This carriage is used to facilitate the implementation of a regular welding. Boiler making in carbon steel.

Angle, butt, overhead and vertical welding with guidance by crabbing arm.

Welding of stiffeners in ship yards.



Angle, butt, overhead and vertical welding. The carriage is travelling on a magnetic or pneumatic rail according the piece to be welded.

Main features

Carriage speed	15 - 120 cm/min	5 - 140 cm/min	15 - 180 cm/min	1 - 180 cm/min
Di mensions (L x l x h)	140x240x220 mm	250x300x260 mm	500x500x600 mm	345x220x255 mm
Weight (netto)	5 kg	11 kg	16 kg	8 kg
Options	Arc protection	Pendular oscillating unit. Linear oscillating unit. Magnetic crabbing rails, aluminium wheels...	-	Pendular oscillating unit. Linear oscillating unit.

MIG/MAG MACHINES

The **MIG/MAG** applications are used in various domains from the simple carriage for shipyard industry to large gantry for train manufacturing.

The choice of the machine depends mainly on the size of the piece to weld.

Lincoln Electric propose solutions according your need.

Beam welder

with two torches to weld beams or frames for structures or automotive industries.

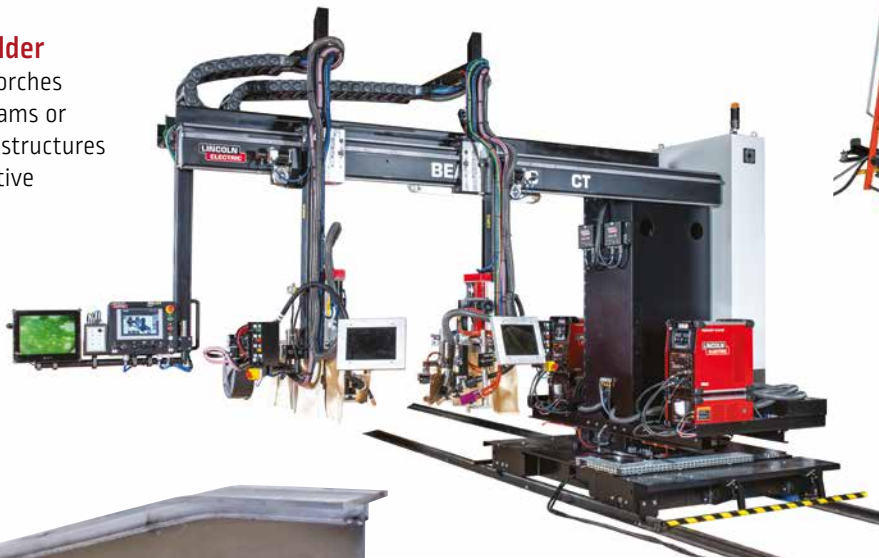

Column & boom

To weld any kind of vessels or tank for many industries.

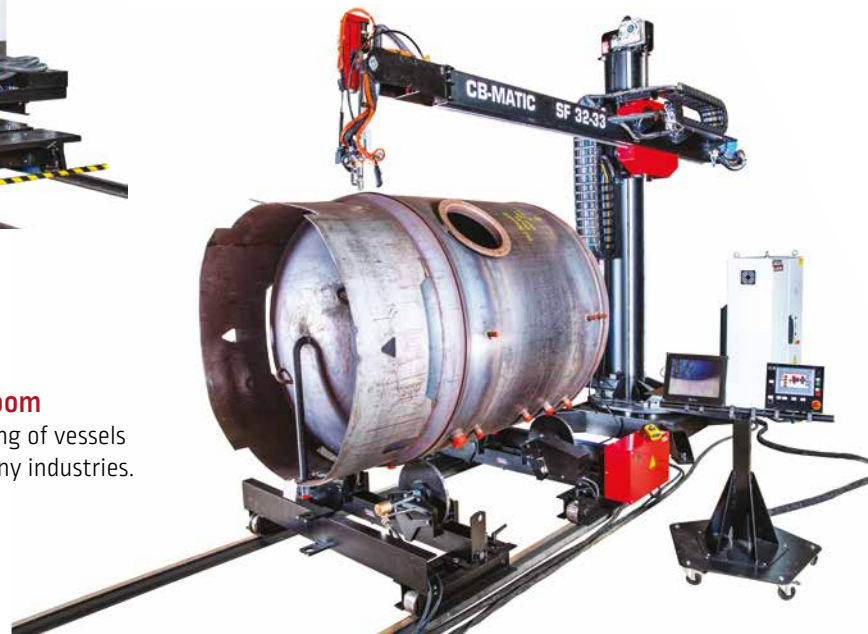

MIG MAG welding aluminium

Gantry with two torches to answer applications requiring a high level of productivity with large pieces such as the manufacture of railway wagons.



ORBITAL AUTOMATED WELDING SYSTEMS GMAW / FCAW / GTAW

The GMAW / FCAW / GTAW welding systems are digital welding solutions for MIG, Flux Cored, Innershield and TIG.

All aspects of the weld are controlled by the system and saved into different programs and passes.

While welding, the operator has the ability to make on-the-move corrections.

These corrections can be set to a specific range by the welding engineer or supervisor.

- **Full control**

The APEX3 series ergonomic hand-held pendant with icon-based interface and full-color screen simplifies the control and monitoring of weld activity

- **Easy to use**

The weld head is a quick release. It allows for tool-less installation and removal from track ring

- **Quick torch set-up**

Tool-less adjustment of the welding torch angles

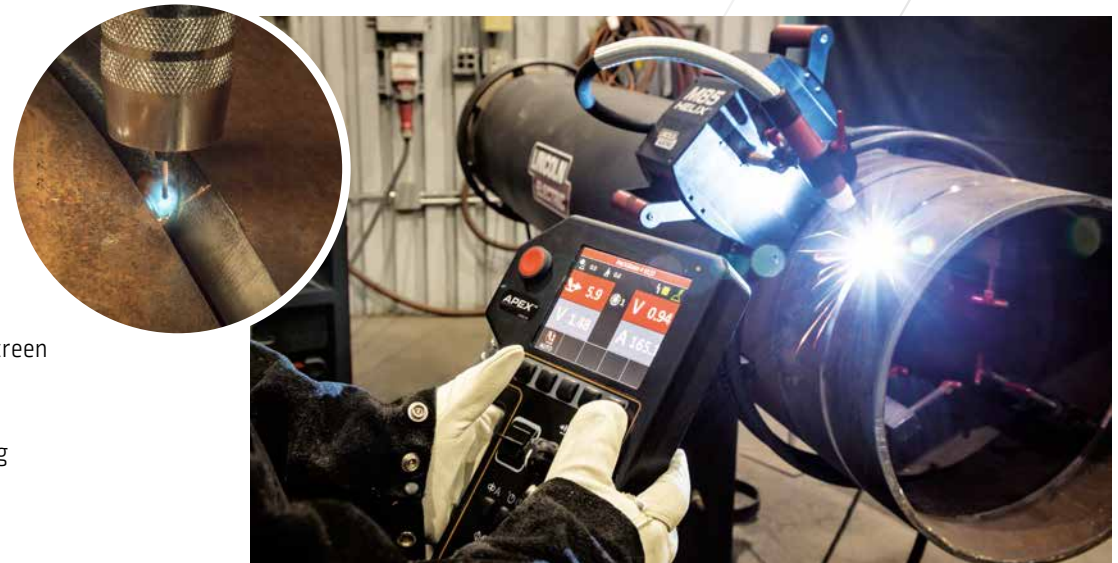

ORBITAL AUTOMATED WELDING SYSTEMS

GMAW / FCAW / GTAW

HELIX M85 weld head

- Compact design
- Quick release system
- Tool free torch set-up
- 8.5" [215 mm] radial clearance without torch
- 14.6" [370 mm] radial clearance with standard MIG torch
- 2" [50 mm] oscillation stroke
- Patented gear drive motor



- Precise motion
- Automatic stickout regulation
- Embedded inclinometer



HELIX M4X weld head

- Compact design
- Quick release system
- Tool free torch set-up
- 4.5" [114 mm] radial clearance
- 3.5" [88 mm] oscillation stroke
- Embedded inclinometer

GTAW



HELIX M627 weld head

- Compact design
- Quick release clamp
- 2.7" [68.5mm] radial clearance
- digital motor control technology
- 1" [25.4mm] oscillation stroke
- Auto height and Auto sector



M627 clamps set
OD come in sizes **from 1,9"** [48.3mm] **to 6,63"** [168.4mm].

TRACKS

OD track rings come in sizes **from 8"** [203 mm] **to 64"** [1623 mm] as standards sizes.

All standard track rings are hinged and open using quick-release latches, significantly reducing the setup time.



Flat Track 48" [1219 mm] can be bolted together to create length tracks as required.

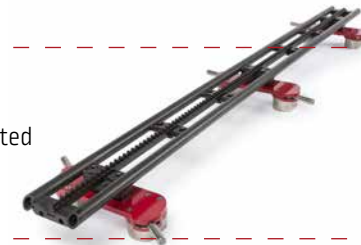

APEX 3 series

- Large friendly screen pendant
- Adapted for use in low light and sunlight



- Ergonomic buttons
- Welding programs management including welding process, motion, mechanical oscillation, stick-out regulation, sectors and passes,
- User management
- Optional operator pendant

POWER WAVE® S500

- High-performance, reliable welding source
- Inverter technology
- 450 A at 100% duty cycle
- Large choice of GMAW and FCAW process
- Optional STT® module



GTAW

TIG PACKAGE



APEX 30S

- Stackable cabinet with Power Wave®
- Included gas solenoid and flow sensor

GMAW - FCAW

MIG PACKAGE



APEX 30M

- Combined control and wire feed
- MAXTRAC® 4 roll drive system
- Best in class torque for reliable wire delivery
- Tool-less drive roll, wire guide and pressure arm adjustment
- Precise wire feed

LINC-COBOT, ROBOTIZE WITH EASE

Across many industries, finding skilled welders is challenging. In finding the best solution, automation is usually the most practical and cost-efficient answer. We combined more than a century of welding knowhow and our extensive automation experience with your real-world needs to create the Linc-Cobot series. This welding cobot range is designed for safe, direct human interaction. It's the affordable, game-changing solution you need to level up your welding and your business.

Intuitive Programming



Intelligent Torch System

Guide the cobot into the correct position by hand, using the torch-mounted enabling device.



Icon-base

Tablet teach pendant, featuring icon-based, timeline programming, reduces the learning curve. Simply swipe icons in the timeline. Including the Lincoln Arc Welding Plug-in.



Dual-Action Pushbutton Interface

Record points directly at the torch, reducing the cumbersome part of programming. The push-button interface, designed directly into the torch, allows the operator to record approach and weld start/end points, as well as change robot motion.



Versatility

Mobile and adaptable

Easily deployed and programmed to weld in minutes. You can quickly automate tasks for improved productivity and throughput. Choose your Cart or Platform version to perfectly fit to your job.

Safe and reliable cobot



Highest Safety

Truly Collaborative Environment thanks to Cobot the design and its intelligent contact-sensing technology allowing the Linc-Cobot to safely work side-by-side with welding operator.



Maintenance free

Reliability is everything. The Cobot is designed for eight years ZERO maintenance on motors, reducers, sensors, cables, and grease – delivering peace of mind, you can trust.

Advance software options

Touch Sensing

Re localise your part to ensure the correct wire placement.

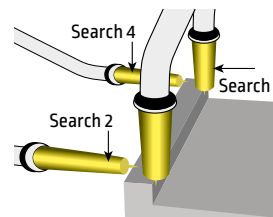

Multi-Pass

Simplify programming of multi-pass welding sequencing, thanks to an ergonomic menu.



Seam tracking

Through Arc Seam Tracking (TAST) will track weld joints. Adjusting torch position laterally and vertically.

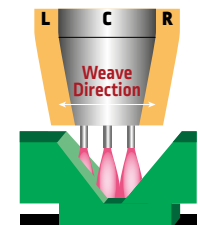

LINC-COBOT, THE RANGE SOLUTIONS

Plug & play package composed of:

- Fanuc CRX 10iA/L with Tablet-Based TP
- Integrated Pushbutton Torch Control
- Power Wave® R450 Robotic Power Source
- AutoDrive® 4R100 Wire Feeder
- Robotic torch
- Cooling system (water cooled package)
- Plug & Play single power input

- Utility drawer & tablet tray,
- Arc visual protection
- Fixed welding Table*
- Heavy duty casters*
- Stabilizing kickstand*



Cart



Platform

Options

CART version	PLATFORM version
Tooling H28 Table 800x800x25 mm	Advance Module
Software pack Touch sensing + Multi-pass + Seam tracking	
MOBIFILTER fume extractor for conventional gun	
Linc-Extractor high vacuum turbine for fume extraction gun	

Arc tool inside

Power Wave® R450 is interfaced with the Linc-Cobot Teach Pendant Tablet, giving access to the complete process control platform.



Weld Mode Number : #18 RapidArc ArMix
 Wire : Steel1.2 mm
 Gas : ArCO2

Change Weld Mode

Current :	185.0 Amps
Trim :	0.9
UltimArc :	0.0
Travel Speed :	55.0 cm/min

Magnum PRO	BW500	FX500
Conventiional	Conventiional	Fume extraction
380A@100%	500A@100%	
Air Cooled	Water cooled	
Steel / Stainless	Steel / Stainless / Aluminium	Steel / Stainless
0.8 - 1.2 mm	0.8 - 1.6 mm	

*for cart version only

FLEX-FAB ROBOTIC WELDING PRE-ENGINEERED CELLS

High productivity solution

- Performing robot with several features and options
- Advanced welding equipment with a large choice of MIG/MAG processes
- Fume extraction and filtration for a better environment
- Optimized wire feeding system with high quality consumables
- Fixture on demand, depending on the application
- Assistance, service and maintenance of your equipment
- Software solutions to manage data and traceability



Robotic welding cells offering the latest technology, ready to use, including:

- **HIGH PERFORMANCE ARC ROBOT** 6-axis high performance and suitable for arc welding
- **HOLLOW WRIST** for a better accessibility and reliability
- **TORCH SERVICE CENTER** for calibration and maintenance
- **SMART TAC** for piece detection and relocalisation
- **DOUBLE WORK STATION** to boost productivity
- **WELDING PACKAGE** Power Wave® R450
- **FENCING PROTECTION** and vertical light curtain

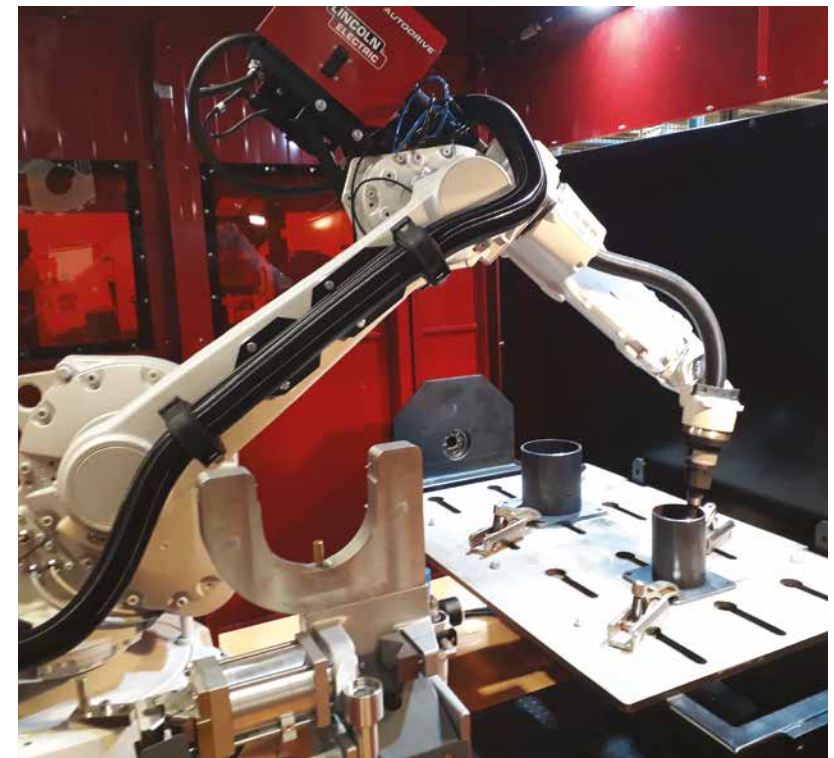

AN OPTIMAL RANGE FOR SMALL TO MEDIUM PARTS

With our Flex-Fab robotic welding cells, we have engineered newer, more advanced and more affordable robotic systems to support manufacturers of all sizes - from the small shop owner to medium part supplier.

An automated robotic welding cell can help you speed up production, reduce labour costs, improve weld integrity and consistency, and reduce downtime.

FLEX-FAB - FT-DS

Benefits:

- Ideal for welding small to medium-sized parts that do not require rotation or repositioning
- Minimal installation
- Improves productivity, quality and safety

Examples of Manufactured Parts:

- Enclosures and boxes, such as electrical panels
- Food service equipment
- Miscellaneous: small brackets, handrails, education institutions



2 fixed tables for 2 work envelopes of 500x500x300 mm and 300 kg weight*.

FLEX-FAB - XFT

Benefits:

- Single load and unload area with two independent work zones
- Turntable system provides 180-degree rotating work area for increased throughput efficiency
- Ideal for small- to medium-sized parts not requiring reorientation
- Promotes optimum use of floor space
- Servo-driven positioner has no mechanical components and is nearly maintenance-free

Examples of Manufactured Parts:

- Construction equipment, such as subassemblies, cylinders
- Heat exchangers
- AC ventilation
- Foodservice equipment
- Miscellaneous: brackets, satellite dish brackets, rebar brackets, couplers, stair treads



1 rotating table max Ø 2450 mm for 2 work envelopes of 1200x700x300 mm and 500 kg weight*.

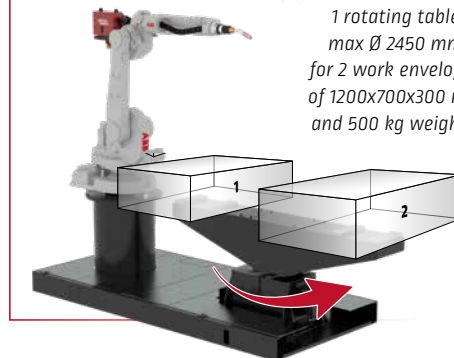

FLEX-FAB - XHS300 FLEX-FAB - XHS600

Benefits:

- Enhance part production by improving productivity, quality and safety
- Dual zone with a rear-mounted robot on an H-Frame positioner
- 180-degree rotation for single load/unload access point
- Smaller arm and system footprint produces higher throughput rates
- Optimized to maximize the work envelope of the robot

Examples of Manufactured Parts:

- Agricultural Equipment
- Recreational Vehicles: cart frame, hitches and components
- Miscellaneous: office furniture, door window frames, water heaters



1 rotating table with 2 headstocks for 2 work envelopes.

XHS300

Ø 1000 - L= 1600 mm - 300 Kg*

XHS600

Ø 1200 - L= 2000 mm - 600 Kg*

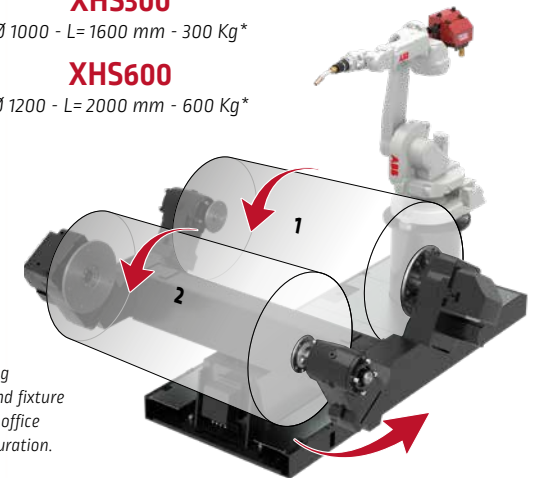

* Theoretical envelop depending on the part to be welded and fixture size. A study by our design office will define the exact configuration.

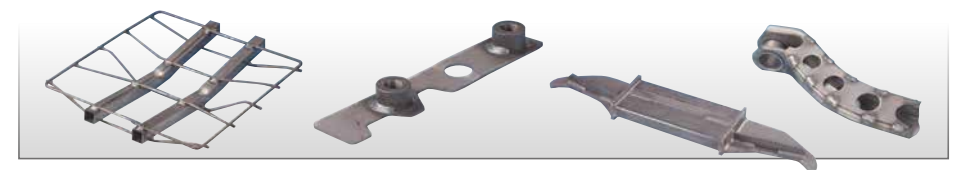

ROBOTIC WELDING CUSTOMISED CELLS

Robolution™, a Lincoln Electric Company, is a full service automation integrator providing engineering, machining, and integrated robotic systems with core competencies in advanced welding system design, high-quality weld fixtures, robotic integration, process automation, and ongoing service and support. Robolution™ is the specialist for customized solutions and high range of fixture systems.



From beginning to end, design - tooling - machining, Robolution™ completes each step in house.

That means total control over:

- Quality
- Lead time
- Cost
- Customer service

So that every step meets the customer's expectations.

The team of professionals operates out of the headquarter in Weiterstadt, Germany but delivers on a global level as part of the Lincoln Electric Automation Group.

Robolution™ is a leader in the:

- Development
- Construction
- Installation
- Sales of robot systems and related components

The product range includes robot systems

incorporating high tech components and extends from standard items of equipment to fully automated, interlinked production lines. Robolution™ is a partner you can trust.

The individual products and installations help ensure the economic success of the customers. Long-lasting and technically faultless products and systems, as well as comprehensive service, are the fundamental elements which guarantee this.



AUTOMATED GUIDED VEHICLES



FORI AUTOMATION, a Lincoln Electric Company, is a full service automation integrator with engineering, software development, assembly and commissioning for turn-key or integration systems.

FORI provides core competencies in the automotive sector for high-quality equipment, integration, process automation and ongoing service and support.

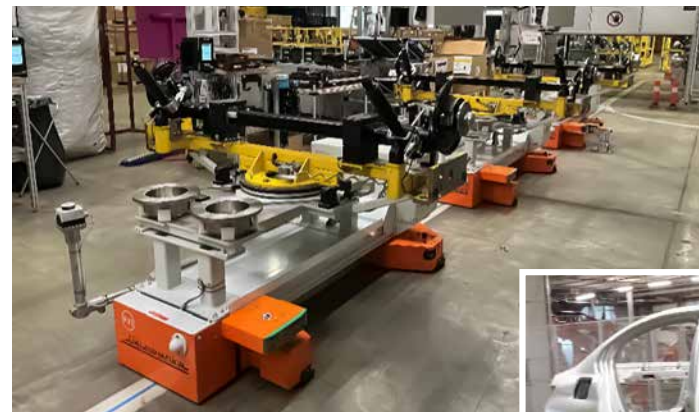

The product range includes AGV systems (*Automated Guided Vehicles*) incorporating high tech components and extends from standard items of equipment to fully automated, interlinked production lines.

The individual products and installations help ensure the economic success of the customers. Long-lasting and technically faultless products and systems, as well as comprehensive service, are the fundamental elements which guarantee this.



SMART AUTOMATION SOLUTIONS

ZEMAN Machines, a Lincoln Electric Company is globally recognised as turn-key specialists, able to create a steel facility from the ground up as a service for our customers.

We offer everything needed to turn your “green field” into a functioning structural steel and/or cladding facility including design, commissioning, all the required logistical, assembly machinery, training and more.

We design and build to the highest standard of automation and efficiency focused on achieving profitability in the fastest possible timeframe.



Fully automated process

Finding skilled welders is a challenge, industries are requiring more quality and competitiveness. Lincoln Electric offer automatic beam assembly from H beams, tubes, channels, additional parts to provide a “ready-to-use” finished product.

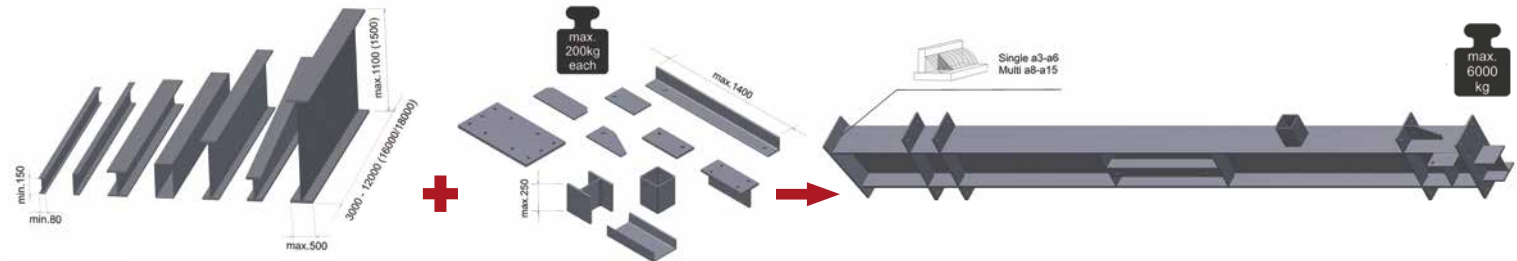

Zero programming



It only takes a few minutes to auto-generate the workflow without programming or teaching the robots, and it doesn't stop there. The significant time and cost savings are during the assembly process, demonstrating a system that can be up to 10 times faster than a traditional manual fitting process.

Key benefits

- No teaching or programming
- Increased production efficiency
- Fast and flexible project execution
- Strong & robust design with max. reliability
- Low labour intensive; 1 operator only
- First-class welds on 1 to 13 passes
- Weld sizes from a3 – a16; 3/16" to 7/8"
- Full dimensional quality check
- Works on non-perfect parts
- Real-time adjustments on the fly
- Ensures highest level of safety
- Different machine models & configurations

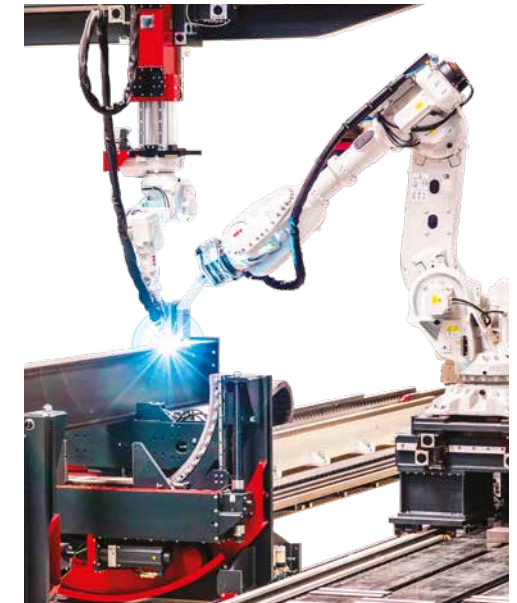

STEEL BEAM ASSEMBLER

The **Steel Beam Assembler (SBA)** represents the flagship of Lincoln Electric's fully automated structural steel beam assembly and welding production line.

The machine can fit and weld large amounts of steel accurately and efficiently. It only takes a few minutes to auto-generate the workflow without programming or teaching the robots.

Handling Robot

The robust & reliable design, precision tracks, designed for the steel industry and its environment, paired with a leading industrial robot equipped with a powerful magnet, ensures the best accuracy.

Turning devices

A heavy duty design with a fully automated rotation allows 360° processing.



Welding Tower

A throughout robust & reliable design, running on high-precision tracks designed for the steel industry and its environment, paired with a leading industrial robot equipped with a laser vision system and welding gun, ensures the best accuracy and quality welds on the market.

Production performance

Sample beam

HEB 220
with 29 add-on parts
Length: 7590 mm
Weight: 717 kg

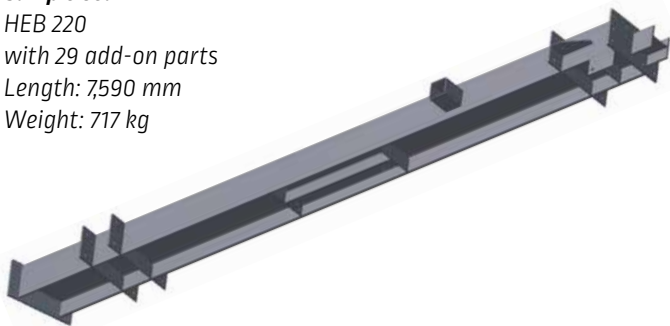

* Dimensions of main beams and add-on parts may vary according to the machine type.

Manufacturing speed

	Minutes			Hours Per Tonnage			Saving in %		
	Assy.	Weld.	Total	Assy.	Weld.	Total	Assy.	Weld.	Total
Conventional production without SBA									
Manual labor	200	170	370	4.63	3.94	8.60			
Automated production with SBA									
SBA Compact	40	125	165	0.93	2.90	3.82	80	26.5	55.5
SBA Compact+	40	105	145	0.93	2.43	3.36	80	38	61
SBA Conti	32	125	157	0.74	2.90	3.63	84	26.5	57.5
SBA Conti+	32	105	137	0.74	2.43	3.17	84	38	63
SBA SR-Compact	63	130	193	1.46	3.00	4.47	68.5	23.5	48

RANGE OF MACHINES



Learn more about the Lincoln Electric's structural factory:



The **Steel Beam Welder (SBW)** is a robotic welding cell that can either weld out manually assembled beams or beams from an SBA, pre-assembled, and partially welded using the same work file generated for the SBA.

The **Steel Beam Assembler (SBA)** fully automated structural steel beam assembly and welding production line. The machine can fit and weld large amounts of steel accurately and efficiently.

Available SBA & SBW models

MODELS	Function		Configuration			Features & available Options						
	Assembly	Welding	DUPLEX	SBA Upgrade	SBA 2 Upgrade	Material rotation	2 nd tower	SYNCRO II	Infeed	Unloading	LINK	Pre-heating
SBW Terminator		X	possible	-	-	automated	-	-	-	-	-	-
SBW Terminator E		X	-	possible	-	automated	-	-	-	-	-	-
SBW Eco		X	possible	possible	-	automated	possible	-	-	-	-	-
SBA SR-Compact*	X	X	-	-	-	automated	-	-	-	-	possible	-
SBA Compact	X	X	-	-	-	automated	possible	possible	possible	possible	possible	possible
SBA Conti	X	X	-	-	possible	automated	possible	possible	possible	possible	possible	possible

STEEL PART SORTER

The **Steel Part Sorter (SPS)** was developed to facilitate plate management for steel fabricators and automate their structural steel beam factory.



Easy operation



Complementary to other Zeman products



Minimize errors



Upgradeable to automated SPS with AGV'S



Automate part handling



100% Quality check



Economic investment



1 part takes 15 seconds

Identifies the required parts ensuring they are within the preset tolerance and meet quality expectations.

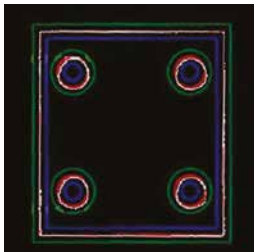

- > White = Should Dimensions
- > Red = Actual Dimensions
- > Green and blue = Present tolerance

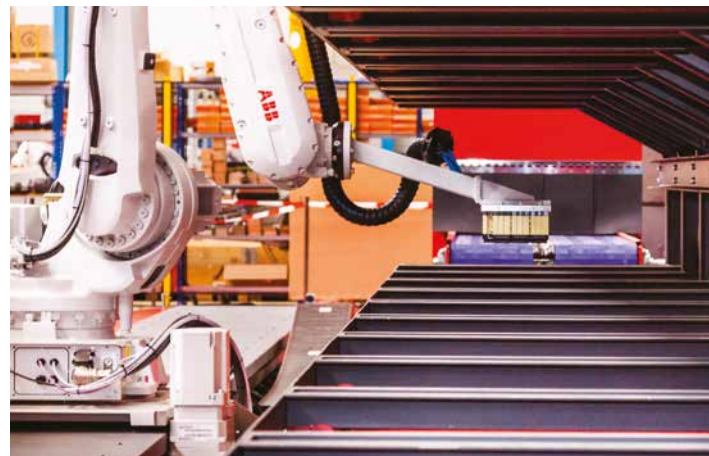

Basic Capabilities

- Data import from your production software
- Scanning / part measurement
- Data comparison / verification
- Sorting, different options: batch, beam, identical parts, etc

Optional

- Marking / scribing of parts (*needle or laser*)
- SMART factory (*RFID*)
- Self Scanning Feed / Pallette Rotator
- LINK
- SPP (*Steel Plate Patroller / AGV*)

PRECISION POWER LASER

Innovative hot wire laser system

Principle

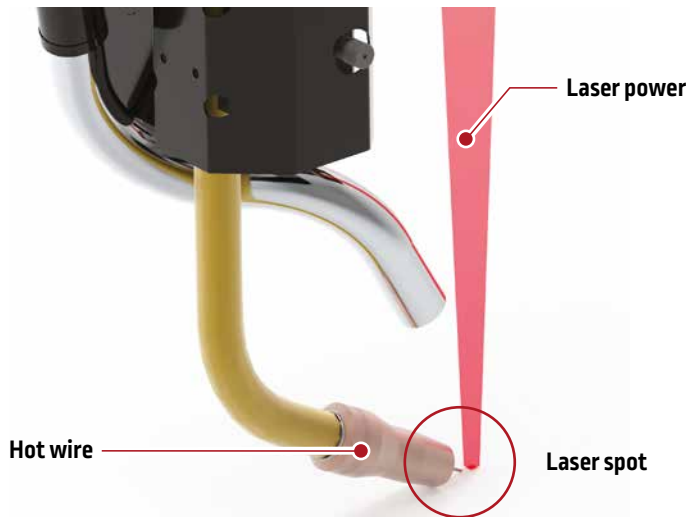

This process is an arc-free, hotwire laser process designed to increase deposition rates and travel speeds by heating the wire to a certain degree before entering it into the laser beam.

Whether welding or cladding, this process can be implemented to improve production rates and increase quality.

- Laser power: 8 kW
- Laser spot: 5 mm
- Hot wire: 2 kW

PPL package

Precision Power Laser core package includes:

- Laser optic with integrated feeder and gun
- Power Wave® R450CE
- AutoDrive® feeder



Standardised integrated head with common Lincoln Electric components make production and support a breeze!



AUTODRIVE®

High performance push-pull wire feeder.



STANDARD POWER WAVE®

with specific PPL waveform ensures that the wire does not form/sustain an arc and increase heat input.

PRECISION POWER LASER

Production value

Precision Power Laser offers the best proposal value compare to any process used in the market today.

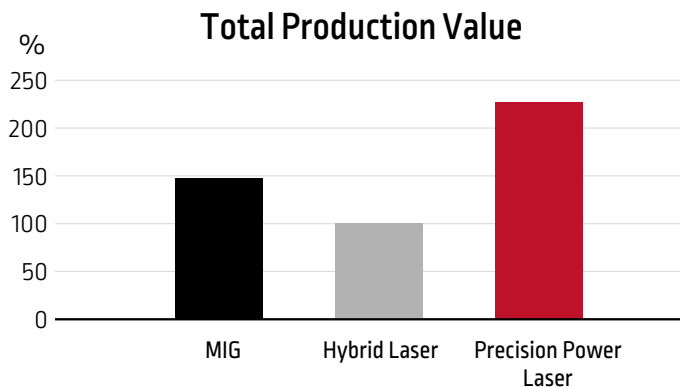

- Hyper productivity thanks to high speed execution and low or no post-processing rework,
- Better tolerance thanks to its larger laser spot,
- Lower distortion thanks to high speed execution and pre-heated wire,
- Lower CAPEX resulting in less equipment investment to perform the same volumes.

Typical applications

Perfect solution for welding EV battery trays

The growing demand for electric vehicle places a tremendous strain on supply chain production and existing technologies. Precision Power Laser is the solution of the future that is here today that solves productivity, investment, flexibility and distortion all in one. Simply apply Precision Power Laser to your battery tray production and eliminate headaches, bottlenecks and constraints.

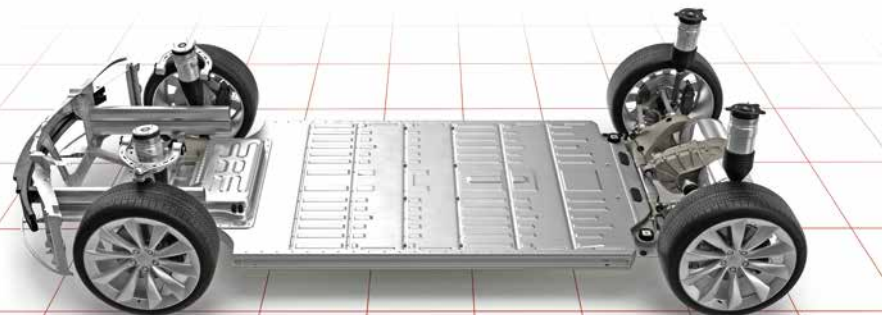

Cladding

The top-hat beam profile of a laser diode used in PPL, creates a particularly even molten pool, which provides fine-grained, pore-free and crack-free coatings of the work pieces.

Examples such as drilling tools, mining industry tools, heat exchangers.

Post-processing is thus reduced to a minimum.

LINC-MATIC-CB-Series: column and booms

Lincoln Electric column and booms are the professional answer to your needs. Ideal for pressure vessels manufacturer of stainless steel, mild steel and light alloy, they maximize your benefit from automatic MIG/MAG, submerged arc, TIG, plasma and plasma+TIG welding processes.

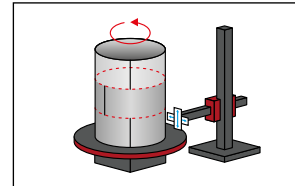
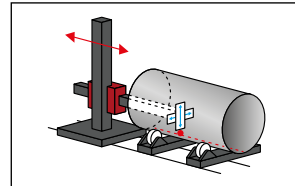
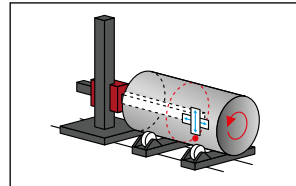
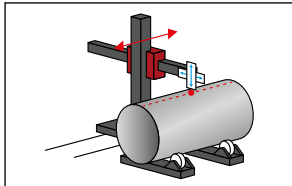
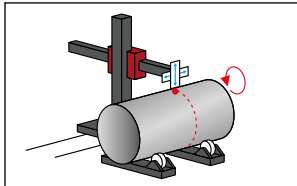
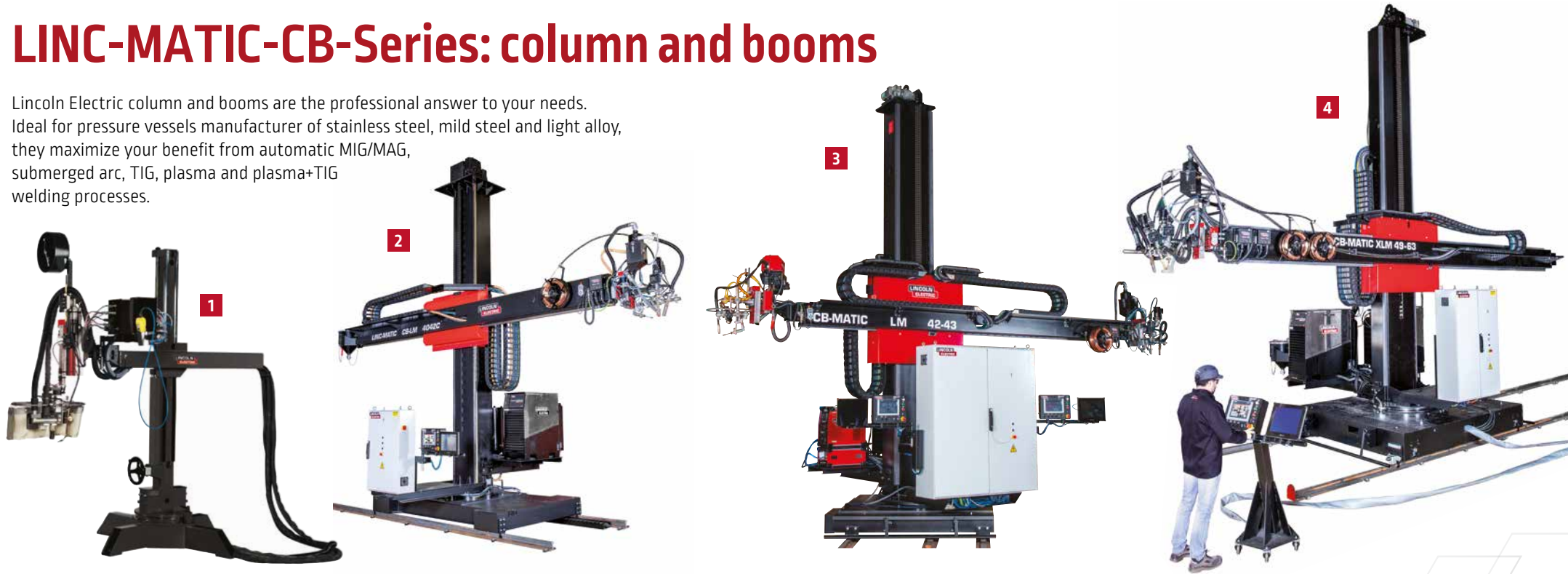

Column and boom choice

According the welding process and the size of the vessels to work on, it is possible to choose Basic, Classic or Evolutive series and XS, L or XL column and boom.

This C&B can be fixed on the ground (F) or mobile on rails (M) and associate with roller beds, positioners, turntables and headstocks.

	B-Series "BASIC"	C-Series "CLASSIC"	E-Series "EVOLUTIVE"	
	1 XS	2 L	3 L	4 XL
Size [Column x Boom in mm]	1,5 x 1	3 x 3 to 6 x 6	2 x 2 to 5 x 5	4 x 4 to 7 x 7
Customization	X	X	✓	✓
Motorized axis	X	✓	✓	✓
PILOT controller	X	✓	✓	✓
Processes	MIG/Single SAW	Single or Tandem SAW	Single or Tandem or Bicephal Plasma / TIG / MIG / SAW	Single or Tandem or Bicephal Plasma / TIG / MIG / SAW

Other dimensions on request.



PILOT PRO Plus controller for a centralised management of the machine.

SEAM-MATIC: welding seamer benches

Lincoln Electric offers a range of seamers specifically designed for horizontal welding, supporting cylindrical (round or square section) or plan workpieces with a wide range of dimensions.

- FIN: external welding, small thickness
- EX: external welding
- IT: internal welding
- EXIT: external and internal welding
- Customized

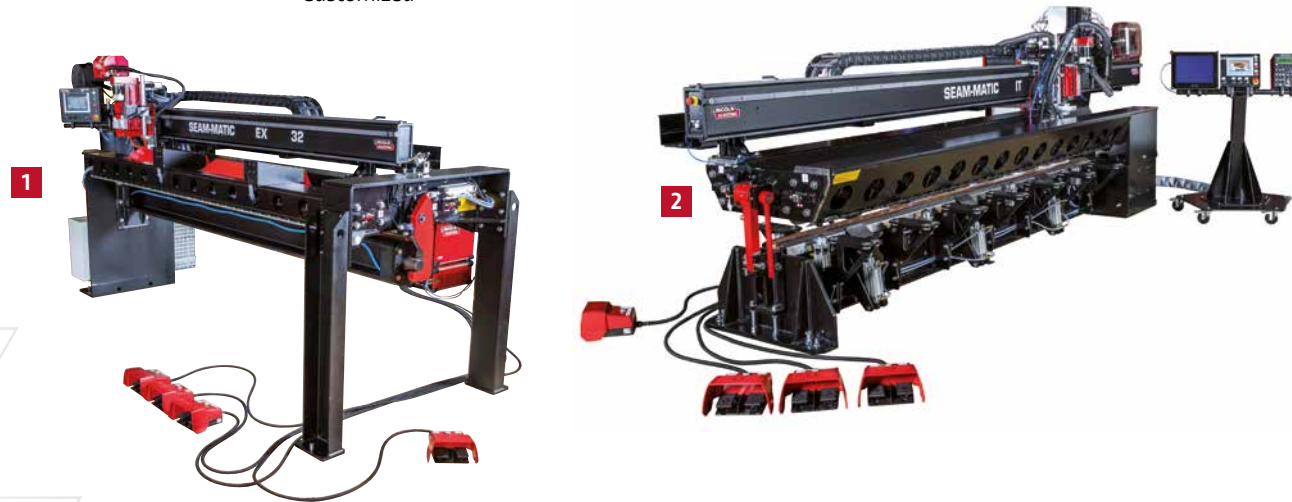

	FIN	EX (xx from 10 to 20)						IT						EXIT			
	10V07	12Vxx	17Vxx	22Vxx	32Vxx	42Vxx	22	32	42	52	62	72	32	42	52	62	
Clamping Length* (mm)	1050	1250	1750	2250	3250	4250	2250	3250	4250	5250	6250	7250	3250	4250	5250	6250	
External welding (mm)	∅ mini	80	210	220	270	320	460	-	-	-	-	-	-	380	480	580	600
	∅ maxi	700	xx00	xx00	xx00	xx00	xx00	-	-	-	-	-	-	1500	1500	1550	1600
Internal welding (mm)	∅ mini	-	-	-	-	-	1450	1500	1500	1550	1600	1650	1500	1500	1550	1600	
Thickness (mm)	without tacking	0.6 to 3	0.8 to 5	0.8 to 5	1 to 5	1 to 5	1 to 5	1 to 5	1 to 5	1 to 5	1 to 5	1 to 5	1 to 5	1 to 5	1 to 5	1 to 5	1 to 5
	with tacking	0.6 to 3	0.8 to 8	0.8 to 8	1 to 8	1 to 8	1 to 8	1 to 10	1 to 10	1 to 10	1 to 10	1 to 10	1 to 10	1 to 10	1 to 10	1 to 10	1 to 10

* Maxi weldable length depends of head's configuration (number of torches and their options). To be confirmed on request.

Other capacity on request.

Customized solutions

According the customer's needs, we could adapt the sizes and the process to reach the best productivity and quality.



External seamer, operator platform.



Plan seamer with Infeed and outfeed table.



Seamer with lifting for variable diameter vessels.

ROTAMATIC ST: single roller beds

Medium-duty roller beds: 2 to 30 tons

- Single powered [one drive roller] for small unbalance work piece
- Double powered [two drive rollers] for work pieces having significant unbalance
- Roller-to-roller center distance adjusting by screw [except for ST 2: by step]
- Remote pendant 5m, kit auto and digital display on all versions

Possible options:

- Kit $\pm 1\%$ speed regulation
- Kit encoder 5000 pts
- Lorry and railway
- Anti-drift



Technical specifications:

Designation	Load capacity [1 drive + 1 idler] kg	Load capacity per section kg	Shell diameter mm	Peripheral speed cm/min	Wheel dimension OD x width mm	Wheel material
ST 2	MT	2000	1000	12 to 120	$\varnothing 150 \times 50$	Polyurethane
	M					
	W					Polyamide
	F					
ST 6	M	6000	3000	12 to 120	$\varnothing 250 \times 75$	Polyurethane
	W					
	F					
ST 15	M	15000	7500	12 to 120	$\varnothing 250 \times 110$	Polyurethane
	W					
	F					
ST 30	W	30000	15000	12 to 120	$\varnothing 350 \times 150$	Polyurethane
	F					

Keys: M = Single motorisation / W = Double motorisation / F = Idler roller / MT = Single motorisation with tube system

ROTAMATIC ST options



Special roller beds
Small 6 tons roller beds
 $\varnothing 100$ to 600 mm



Lorry

The lorry allows to move the roller beds with or without the piece. They can be manual or motorized.

Anti-drift device

The end stop device allows the piece to turn without drifting.

An automatic solution can be proposed with a PLC which controls the idler roller positions.

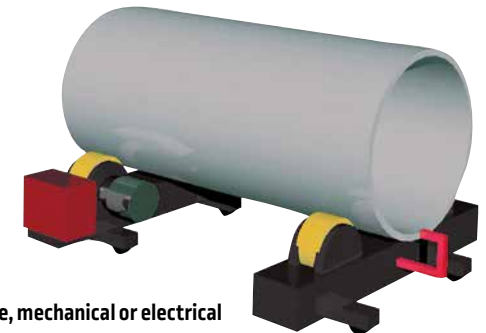

Anti-drift device, mechanical or electrical

ROTAMATIC LP: single roller beds

Heavy-duty roller beds: 42 to 200 tons

- Each rotator is composed of a mechanical structure and rotation roller motorized with roller adjustment by step or screw. In the motorized version, the rotator is equipped with an electrical cabinet
- Double powered [two drive rollers] for work pieces having significant unbalance
- Remote pendant with 10m cable, kit auto and digital display on all versions

Possible options:

- Kit $\pm 1\%$ speed regulation
- Kit encoder 5000 pts
- Lorry and railway
- Anti-drift



Technical specifications:

Designation	Load capacity [1 drive + 1 idler] kg	Load capacity per section kg	Shell diameter mm	Peripheral speed cm/min	Wheel dimension OD x width mm	Wheel material
LP42	42000	21000	700 to 5000	10 to 100 or 9 to 180	Ø 400 x 200	Steel
					Ø 400 x 250	Polyurethane
LP55	55000	27500	700 to 5000	10 to 100 or 9 to 180	Ø 400 x 250	Steel
					Ø 400 x 300	Polyurethane
LP70	70000	35000	900 to 6000	10 to 100 or 8 to 160	Ø 460 x 250	Steel
					Ø 460 x 300	Polyurethane
LP100	100000	50000	900 to 6000	10 to 100 or 8 to 160	Ø 450 x 250	Steel
					Ø 450 x 300	Polyurethane
LP160	160000	80000	1200 to 6000	10 to 100 or 9 to 160	Ø 450 x 300	Steel
LP200	200000	100000	1200 to 6000	10 to 100 or 10 to 160	Ø 500 x 300	Steel



Higher capacity roller beds on request.

ROTAMATIC TR: fit-up roller beds

Fit-up roller beds: 30 to 200 tons

- Idler roller bed section in combination with motorized conventional LP roller bed
- In standard, the up and down movement is made by a manual hydraulic pump

Possible options:

- Automatic hydraulic central pump, recommended for 2 sections configuration
- Lorry and railway



Version with automatic hydraulic central for 2 rotators set



Technical specifications:

Designation	Load capacity [2 fit-up] kg	Lifting capacity per section kg	Shell diameter mm	Wheel dimension OD x width mm	Wheel material	Wheels adjustment
TR30	30000	15000	700 to 4500	∅ 300 x 160	Polyurethane	Screw
TR42	42000	21000	700 to 5000	∅ 350 x 250	Polyurethane	Screw
TR55	55000	27500	700 to 5000	∅ 350 x 250	Polyurethane	Screw
TR70	70000	35000	900 to 6000	∅ 400 x 300	Polyurethane	Screw
TR100	100000	50000	900 to 6000	∅ 400 x 250	Steel	Step
TR160	160000	80000	1200 to 6000	∅ 450 x 250	Steel	Step
TR200	200000	100000	1200 to 6000	∅ 450 x 300	Steel	Step

Higher capacity roller beds on request.

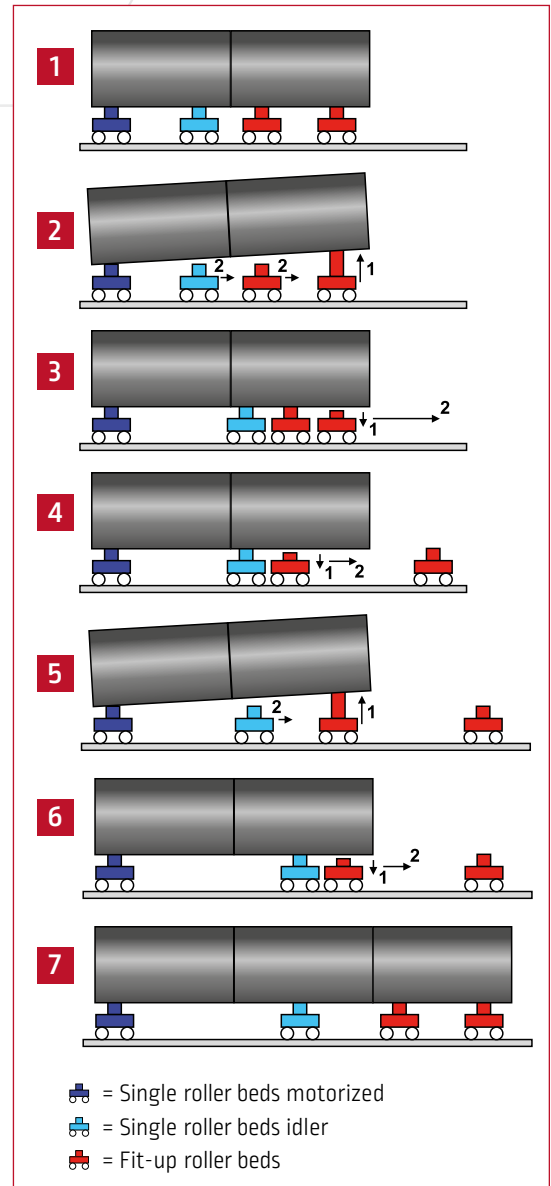

ROTAMATIC LP-2R: self aligning roller beds

12 to 250 tons

- Each roller bed is composed of a mechanical structure and rotation roller motorized or not
- The motorized version is equipped with remote pendant with 10 m cable, kit auto and digital display on all versions
- All 4 wheels are motorized for excellent grip

Possible options:

- Kit $\pm 1\%$ speed regulation
- Lorry and railway
- Kit encoder 5000 pts
- Anti-drift

Technical specifications:

Designation	Load capacity (1 drive + 1 idler) kg	Load capacity per section kg	Mini Shell diameter for 1/2 load mm	Shell diameter for maximum load mm	Peripheral speed cm/min	Wheel dimension OD x width mm	Wheel material
LP12-2R	12000	6000	500	1500 to 4000	10 to 100 or 10 to 200	\varnothing 300 x 220	Rubber
LP20-2R	20000	10000	500	1500 to 4000	10 to 100 or 10 to 200	\varnothing 350 x 300	Rubber
LP30-2R	30000	15000	500	1500 to 4500	10 to 100 or 8 to 160	\varnothing 400 x 300	Rubber
LP42-2R	42000	21000	500	1500 to 5000	10 to 100 or 9 to 180	\varnothing 400 x 400	Rubber
LP55-2R	55000	27500	800	1800 to 5000	10 to 100 or 9 to 180	\varnothing 500 x 230	Rubber
LP70-2R	70000	35000	800	1800 to 6000	10 to 100 or 9 to 180	\varnothing 500 x 400	Rubber
LP100-2R	100000	50000	600	1500 to 6000	10 to 100 or 8 to 160	\varnothing 420 x 300	Polyurethane
LP160-2R	160000	80000	1000	1500 to 6000	10 to 100 or 8 to 160	\varnothing 460 x 300	Polyurethane
LP200-2R	200000	100000	1000	1500 to 7000	10 to 100 or 7.5 to 150	\varnothing 500 x 300	Steel
						\varnothing 500 x 300	Polyurethane
LP250-2R	250000	125000	1000	1500 to 7000	10 to 100 or 7.5 to 150	\varnothing 500 x 300	Steel
						\varnothing 550 x 400	Polyurethane

Higher capacity roller beds on request.

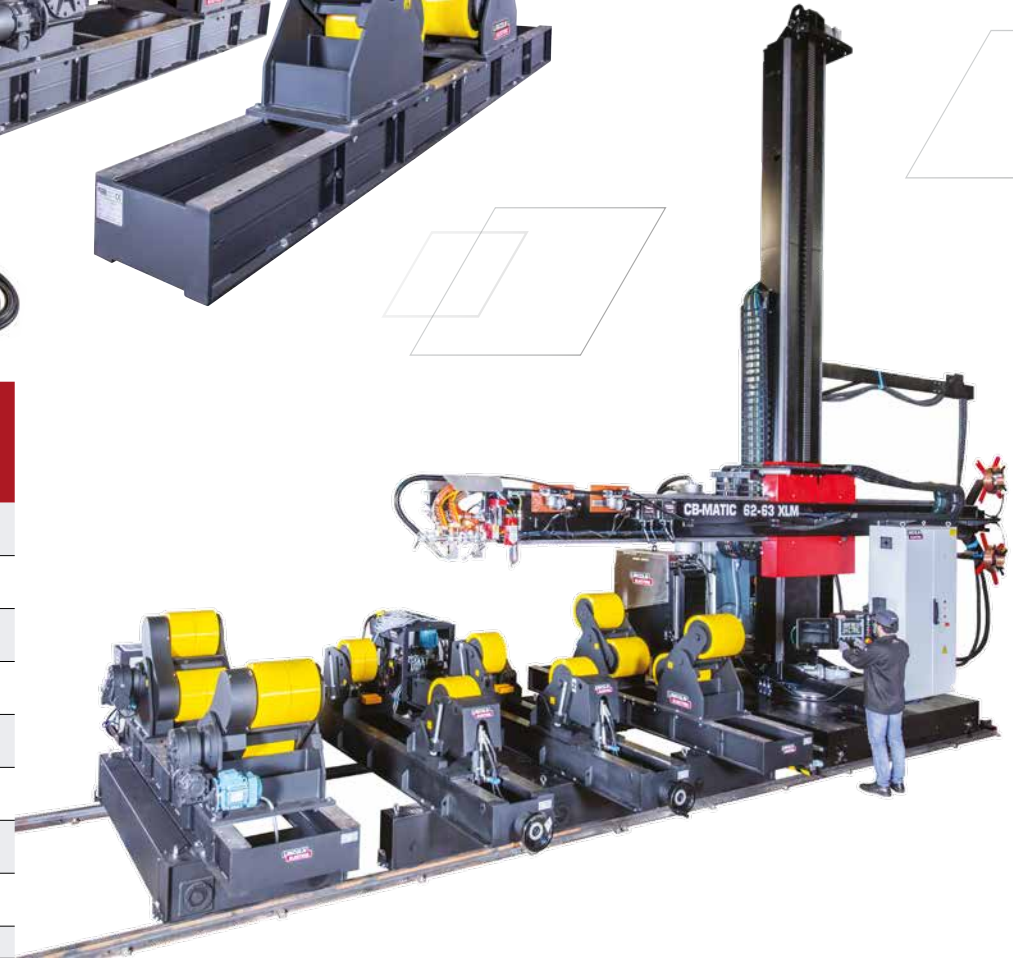

POSIMATIC: positioners



P 1E - P 2E

Light range 2 axis
50 to 200 kg

PS 03 to PS 30

Medium range 2 axis
300 to 3000 kg



TP 4 to TP 30

Heavy range 2 axis
4000 to 30000 kg



TPE 1.5 to TPE 10

Heavy range 3 axis
1500 to 10000 kg



APSi 750 to 35000

Heavy range 3 axis programmed
750 to 35000 kg

	Load all positions Kg (P)	Rotation speed Tr/min	Tilt Torque m.Kg (C1)	Rotation torque m.Kg (C2)	Axis-plate distance m (D)	Turntable height mm
P 1E	50	0.2 to 5	4.5	2	0.075	385
P 2E	200	0.25 to 5	40	4	0.070	500
PS 03	300	0.2 to 3	100	35	0.080	660
PS 08	800	0.16 to 2.4	280	120	0.148	848
PS 15	1500	0.14 to 1.8	550	225	0.151	1051
PS 30	3000	0.1 to 1.5	1300	450	0.222	1222

	Load all positions Kg (P)	Rotation speed Tr/min	Tilt Torque m.Kg (C1)	Rotation torque m.Kg (C2)	Axis-plate distance m (D)	Turntable height mm
TP 4	4000	0.045 to 0.45	1100	500	0.160	1130
TP 6	6000	0.03 to 0.3	2500	720	0.175	1165
TP 8	8000	0.025 to 0.25	3600	850	0.175	1050
TP 10	10000	0.022 to 0.22	6750	1450	0.200	1150
TP 15	15000	0.02 to 0.2	10300	2100	0.240	1315
TP 20	20000	0.018 to 0.18	14200	2900	0.270	1370
TP 30	30000	0.015 to 0.15	22500	4400	0.300	1425
TPE 1.5	1500	0.06 to 0.6	375	160	0.120	970 to 1700
TPE 2.5	2500	0.06 to 0.6	600	200	0.140	1080 to 1850
TPE 4	4000	0.045 to 0.45	1100	500	0.160	1060 to 2010
TPE 6	6000	0.035 to 0.35	2500	720	0.175	1125 to 2125
TPE 8	8000	0.025 to 0.25	3600	850	0.175	1125 to 2125
TPE 10	10000	0.022 to 0.22	6750	1450	0.200	1150 to 2350
APSi 750	750	0.09 to 2	150	60	0.127	730 to 1450
APSi 1500	1500	0.07 to 1.3	300	100	0.128	780 to 1550
APSi 3500	3500	0.08 to 1.6	750	280	0.171	980 to 1750
APSi 7000	7000	0.05 to 1	1400	900	0.184	1000 to 1850
APSi 10000	10000	0.04 to 0.75	4000	1300	0.196	1090 to 2030
APSi 15000	15000	0.04 to 0.75	7000	1800	0.232	1300 to 2330
APSi 25000	25000	0.02 to 0.4	17500	4000	0.319	1600 to 2860
APSi 35000	35000	0.02 to 0.4	28000	5500	0.318	2000 to 3500

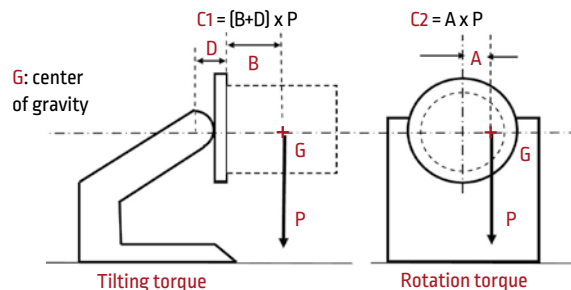

Higher capacity or different rotation speed range on request.

HEADMATIC: headstock

HEADMATIC 2 axis HMM range

Heavy range from 2 T to 30 T

Headstock and tailstock synchronized on rotation and height to handle large workpiece.

Options:

- Programmed position
- Foot pedal
- Movable headstock
- Railway guiding
- Earth contact

	Capacity (Kg)	Rotation speed (Tr/min)	Rotation torque (N.m)	Lifting speed (mm/min)	Axis height (mm)
HMM 2	2000	0.25 to 1	3000	560	350 to 1800
HMM 4	4000	0.25 to 1	3500	560	350 to 1900
HMM 5	5000	0.25 to 0.9	4000	560	400 to 1950
HMM 6	6000	0.2 to 0.75	5500	560	450 to 1950
HMM 10	10000	0.3 to 1.1	7500	650	500 to 1950
HMM 12	12000	0.3 to 1.1	10000	650	550 to 1950
HMM 15	15000	0.3 to 1.3	15000	650	550 to 2000
HMM 20	20000	0.2 to 0.9	22000	560	550 to 1850
HMM 25	25000	0.2 to 0.9	25000	470	700 to 1850
HMM 30	30000	0.2 to 0.75	35000	290	750 to 2000



HEADMATIC 3 axis SPSi range

Heavy range from 750 Kg to 15 T

Dedicated for most complex product geometry, and set up in a wide variety of positions. Remote control for all functions.

Options:

- Programmed position
- Foot pedal
- Wireless remote control



	Capacity (Kg)	Rotation speed (Tr/min)	Tilting torque (N.m)	Rotation torque (N.m)
SPSi 750	750	0.09 to 2	1500	600
SPSi 1500	1500	0.07 to 1.3	3000	1000
SPSi 3500	3500	0.08 to 1.6	6000	2800
SPSi 5000	5000	0.05 to 1	10000	6000
SPSi 10000	10000	0.04 to 0.75	20000	18000
SPSi 15000	15000		40000	18000

Higher capacity or different rotation speed range on request.

Customized solutions

According to the customer's needs, we could adapt the sizes and the process to reach the best productivity and quality.

Pipe support with SUPER TOP headstock 1 axis combined with X roller beds



HEADMATIC 2 axis for machine integration

- Precised motion
- High torque capacity
- Can be used without tailstock



TURNMATIC: turntable

Turntable 5 to 30 tons

Circular welding can be done by the movement of the turntable without moving the torch.

In the standard range, a turntable can make the rotation of shells up to 30 tons and up to 4500 mm diameter. Kit $\pm 1\%$ speed regulation.

Possible options:

- Backing gas device
- Tooling & arms

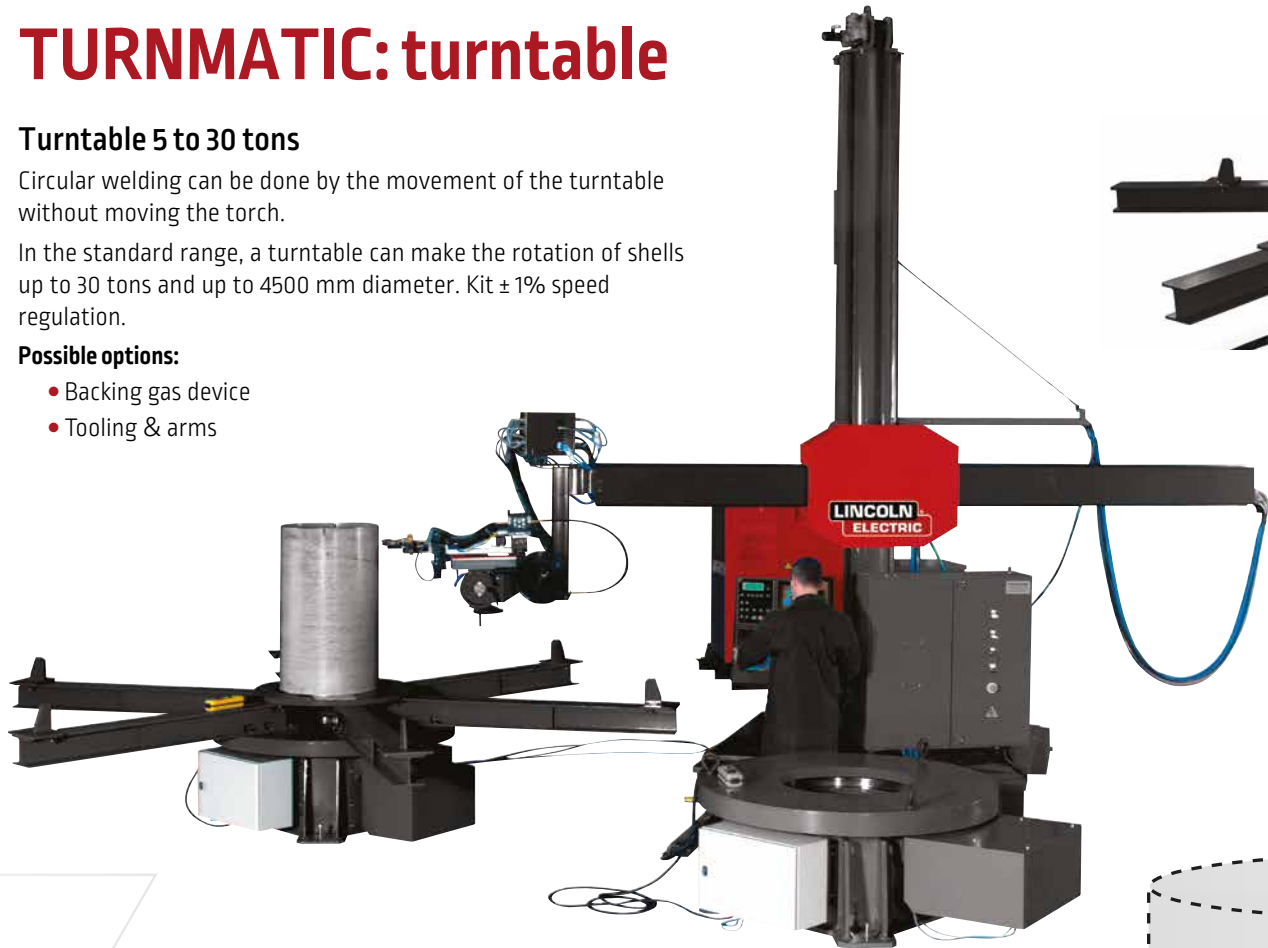

Designation	Load capacity (kg)	Mini shell diameter (mm)	Maxi shell diameter (mm)	Rotation speed (tr/min)
TURNMATIC 5 T	5000	1200	4500	0.004 to 0.204
TURNMATIC 10 T	10000	1000	4500	0.004 to 0.204
TURNMATIC 20 T	20000	1000	4500	0.004 to 0.204
TURNMATIC 30 T	30000	1000	4500	0.004 to 0.204

Other sizes, capacities or rotation speed range on request.

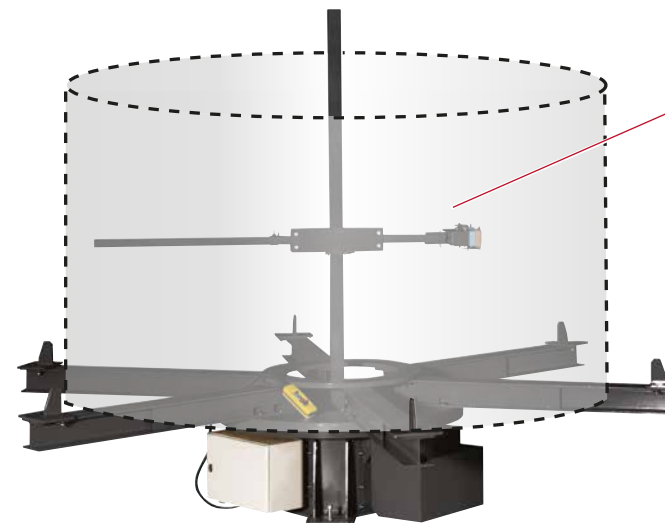

Backing gas device

The backing gas device mounted on turntable, complete the turn-key solution of plasma or TIG welding column and boom.

A man hole in the turntable allows the operator to adjust the backing gas device inside the shell.

**LINCOLN
ELECTRIC**



SERVICES

SERVICES

Lincoln Electric services: a complete offer for your production tools.

Far beyond the simple recommendation of processes or equipment, Lincoln Electric work with you in the service field by offering advice and expertise, demonstrations, feasibility studies, installation and commissioning of facilities, training and assistance to the start of production, maintenance, after-sales service and even upgrade of your equipment.



Solution Centers for Automation

In our Solution Centers it's possible to see and test our cutting and welding systems of the latest generation, which are used for demonstrations and the supply of technical assistance.

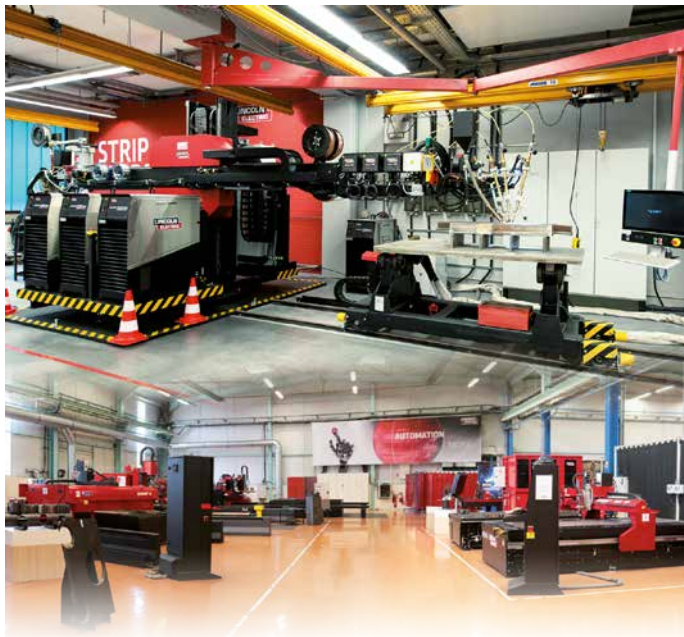

Advices and Expertises

On the basis of a personalised diagnosis, our technical specialists will analyse your needs, identify potential improvements, build solutions along with you, define action plans and give you the support you need. In your premises or in our Solution Centers for Automation.



Call Centers

A large team of technicians can answer to every question and keep your manufacturing tools to their best performance levels.



Remote Service

Lincoln Electric offers innovative services with securely connected machines in order to increase performance of your tool:

- On line intervention allowing reduction of machines' down time.
- On line assistance and training for optimisation of your productivity.

SERVICES

Machine installation and training

Dedicated teams are worldwide available to install your machines and train your manufacturing staff.

Our know-how is well known and our expertise based on experience is here to propose a large range of high quality training with customised solutions.



Production support

You have just invested in a new welding or cutting equipment and would like support while you start up the manufacturing process. Lincoln Electric can offer technical assistance aimed at helping you produce parts independently as soon as possible, by providing step-by-step tracking for the first pieces you turn out.



Upgrading your processes and machines

The retrofitting and upgrading services offer enhancement of life duration of your machines while giving new functionalities and new performances and applications.



Maintenance

Lincoln Electric maintenance contracts provide the guarantee of a high performance level for your equipment.

The optimisation of the availability rate and of the life duration of your machines is key regarding your production costs.



ARC FACILITIES Application Resource Centers

Application Resource Centers, also known as ARC facilities, house Lincoln Electric's latest technologies and professionals, who help develop and deliver productivity solutions that create new opportunities for our current and future customers.

ARC facilities include dedicated spaces and equipment to demonstrate and test welding, cutting, virtual welding, and automation solutions.

In addition each ARC includes classroom areas for instruction on the processes, machines, and consumables solutions available to them.

www.lincolnelectriceurope.com

Stay Connected



www.youtube.com/channel/UCjmontoTpXR12liNT_7Z1bA



www.facebook.com/LincolnElectricEurope



www.linkedin.com/company/lincoln-electric-europe



www.instagram.com/lincolnelectriceurope



ISO
OERLIKON

ISO OERLIKON AG Schweisstechnik

CH-5737 Menziken AG – Tel. +41 (0)62 771 83 05

E-Mail info@iso-oerlikon.ch – www.iso-oerlikon.ch

CUSTOMER ASSISTANCE POLICY

The business of Lincoln Electric is manufacturing and selling high quality welding equipment, consumables, and cutting equipment. Our challenge is to meet the needs of our customers and to exceed their expectations. On occasion, purchasers may ask Lincoln Electric for information or advice about their use of our products. Our employees respond to inquiries to the best of their ability based on information provided to them by the customers and the knowledge they may have concerning the application. Our employees, however, are not in a position to verify the information provided or to evaluate the engineering requirements for the particular weldment. Accordingly, Lincoln Electric does not warrant or guarantee or assume any liability with respect to such information or advice. Moreover, the provision of such information or advice does not create, expand, or alter any warranty on our products. Any express or implied warranty that might arise from the information or advice, including any implied warranty of merchantability or any warranty of fitness for any customers' particular purpose is specifically disclaimed.

Lincoln Electric is a responsive manufacturer, but the selection and use of specific products sold by Lincoln Electric is solely within the control of, and remains the sole responsibility of the customer. Many variables beyond the control of Lincoln Electric affect the results obtained in applying these types of fabrication methods and service requirements.

Subject to Change – This information is accurate to the best of our knowledge at the time of printing. Please refer to www.lincolnelectriceurope.com for any updated information.



www.lincolnelectriceurope.com

